

# MODUL R 280 PROJECT

Deckenleuchte für Direktmontage mit Light Control  
ceiling luminaire for direct mounting with Light Control

nimbus<sup>x</sup>

## MONTAGE / MOUNTING

552-842 . 552-841 . 552-843



Montage und Betrieb nur in Innenräumen!  
Mounting and use of luminaire only indoors!

- A** Direktmontage in abgehängter Decke  
direct mounting in a suspended ceiling

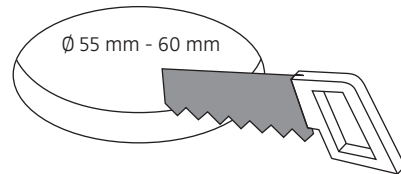
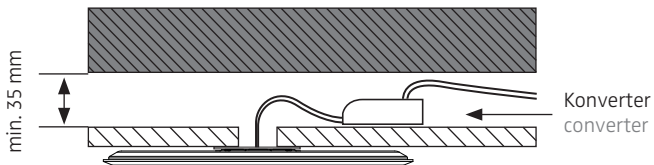

- B** für Hohlraumeinbau in poröse Materialien mit geeigneter Hohlraumdose  
for installation in porous materials with suitable ceiling junction box

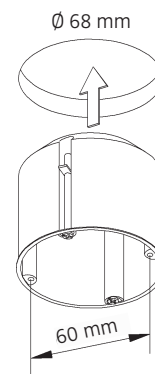
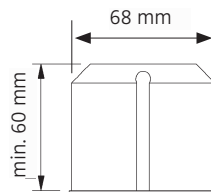
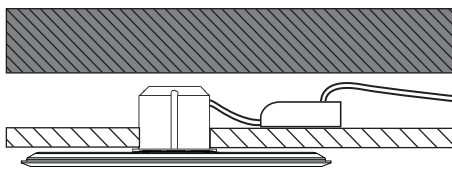

- C** für Unterputz / Mauerwerk mit geeigneter Decken-Verbindungsdose  
for brick / hollow blocks with suitable ceiling junction box

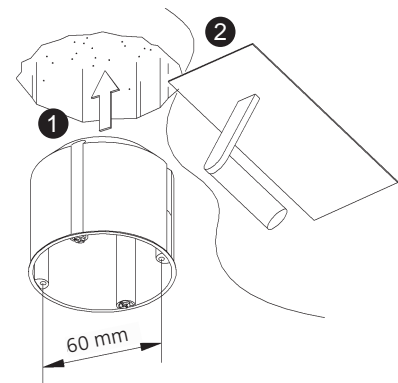
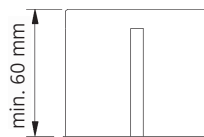
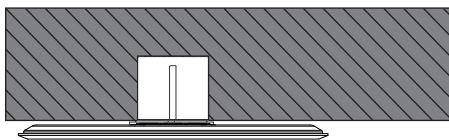

- D** Montage in Decken-Verbindungsdose für Beton (z.B. Spelsberg U71)  
installation in ceiling junction box for concrete (e.g. Spelsberg U71)

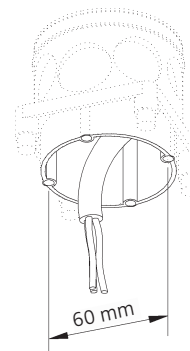
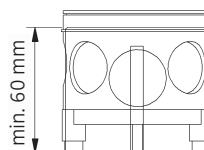
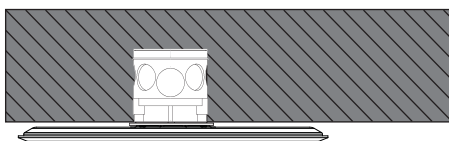

Anschluss mit 230 V ~  
connection to 230 V AC

Eventuell vorhandenen Schutzleiter isolieren und in der abgehängten Decke unterbringen!  
Insulate possible PE-wire and place it inside of the suspended ceiling!

Konverter je nach Baugröße in Deckendose oder abgehängter Decke platzieren.  
Depending on its size place converter inside of the ceiling box or in the suspended ceiling.

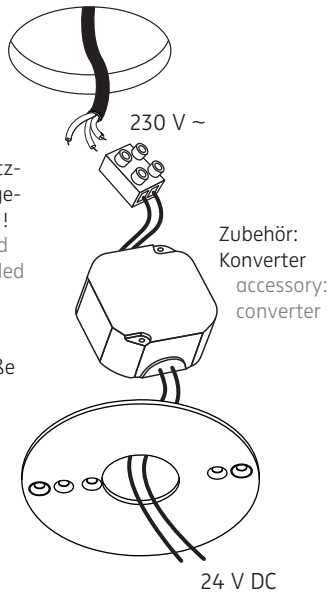

Anschluss an 24 V DC  
connection to 24 V DC

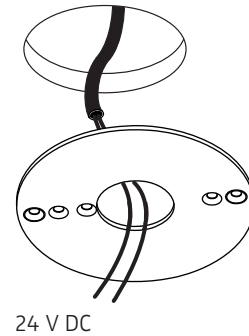

Der elektrische Anschluss darf nur vom Fachmann ausgeführt werden!  
Must be installed by a qualified electrician only!

1

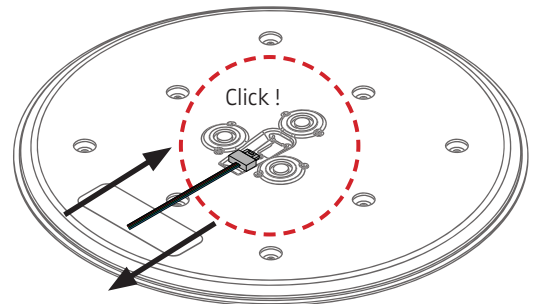
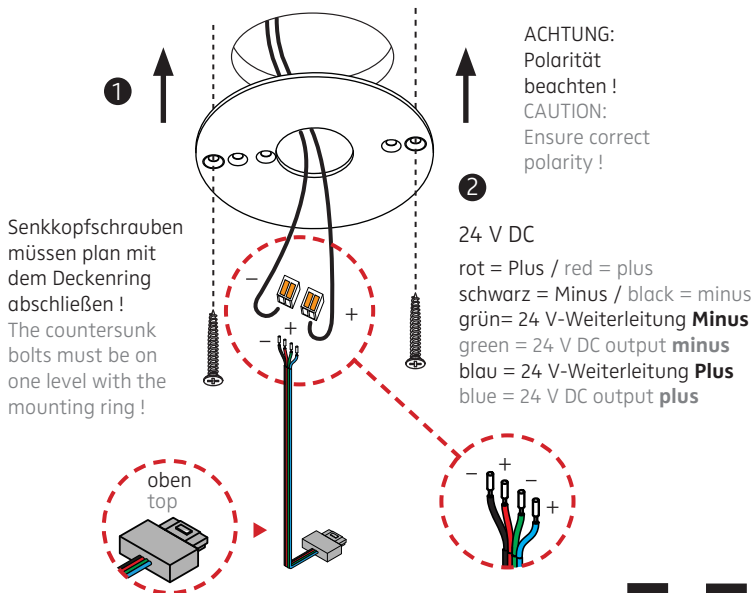

ACHTUNG: Leuchte NICHT an der Zuleitung hängen lassen. Zum Lösen der 24 V-Steckverbindung NUR horizontal in Richtung des Kabels ziehen!  
CAUTION: Do NOT suspend luminaire from this supply cord. To detach the 24 V connection ONLY pull horizontally in the direction of the cable!

2

3

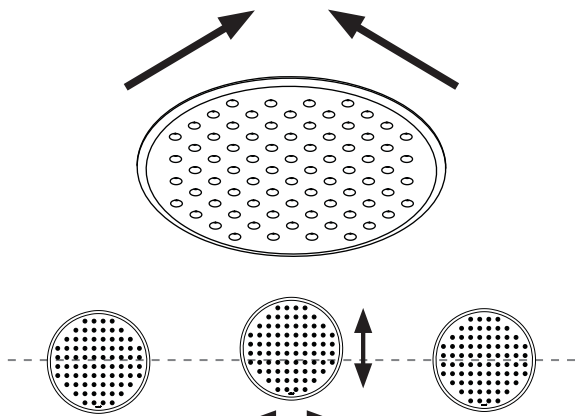
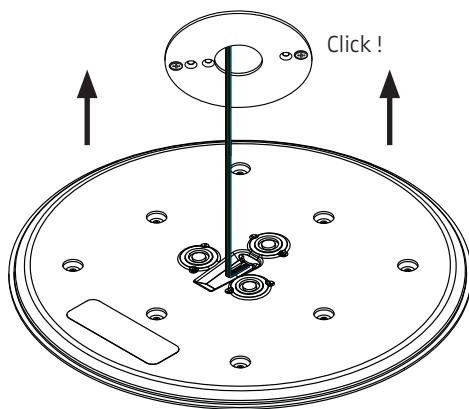

4

5

552-842 . 552-841 . 552-843

Leistungsdaten siehe Typenschild!  
Performance data see rating label!

24 V DC Konstantspannung  
24 V DC constant voltage

Schutzart IP 20  
protection degree IP 20

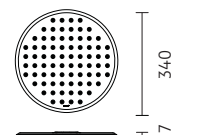

# MODUL R 280 PROJECT

Deckenleuchte für Direktmontage mit Light Control  
ceiling luminaire for direct mounting with Light Control

nimbus<sup>x</sup>

552-842 . 552-841 . 552-843

**HINWEIS:** Die Light Control Bedienungsanleitung finden Sie auf unserer Homepage unter:  
**Service > Downloads > Bedienungsanleitungen > Quick-Start-Guide Light Control.**  
Als Alternative können Sie auch diesen QR-Code mit Ihrem Smartphone scannen.

**NOTE:** You will find the instruction manual for Light Control on our homepage:  
**Service > Downloads > Manuals > Quick-Start-Guide Light Control.**  
Alternatively you can scan the QR code with your smart phone.



## ACHTUNG:

Die 24 V-Weiterleitung gibt das gedimmte oder geschaltete Signal an die nachfolgenden Leuchten weiter. Im Rahmen der verfügbaren Konverterleistung lassen sich somit Dimmgruppen bilden. Die zulässige Gesamtbelastbarkeit eines solchen Systems inklusive Masterleuchte liegt bei 75 W / 3 A !

**HINWEIS:** Ungenutzte Adern unbedingt isolieren !

## CAUTION:

The 24 V output connection delivers the dimmed or switched signal to the following luminaires. So it is possible to build dimming groups within the available converter power. The permitted power handling of such a system amounts up to 75 W / 3 A including the master luminaire !

**NOTE:** Unused wires must be isolated !

Deckenmontagering für  
MODUL R 280 PROJECT / MODUL R 340 PROJECT

ceiling mounting ring for  
MODUL R 280 PROJECT / MODUL R 340 PROJECT

