

NIMBUS R 9

Deckenring für Hohlraumeinbau / bracket for cavity mounting

nimbus^x

MONTAGE / MOUNTING

007-404



Montage und Betrieb nur in Innenräumen!
Mounting and use of luminaire only indoors!

A Direktmontage in abgehängter Decke
direct mounting in a suspended ceiling

erforderliche Deckenöffnung
necessary ceiling opening

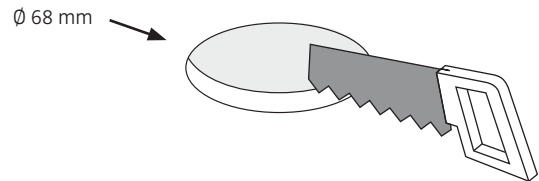
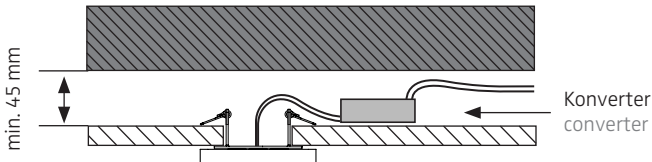

Anschluss mit 230 V ~
connection to 230 V AC

Anschluss an 24 V DC
connection to 24 V DC

Eventuell vorhandenen Schutzleiter (PE) isolieren und in abgehängter Decke unterbringen!
Insulate possible PE-wire and place it inside of the suspended ceiling!

Zubehör: Konverter (sekundär 24 V DC)
SELV muss bereitgestellt werden!
accessories: converter (output 24 V DC)
SELV must be provided!

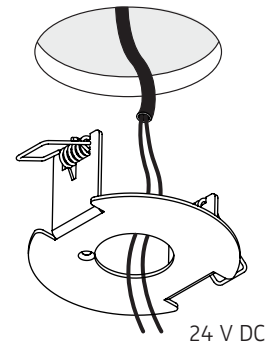
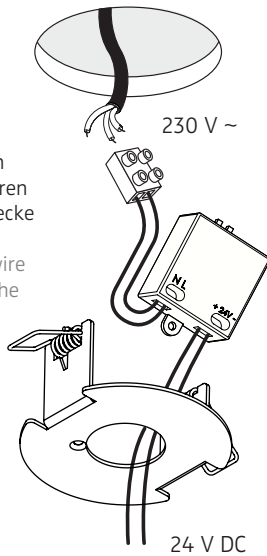

Der elektrische Anschluss darf nur vom Fachmann ausgeführt werden!
Must be installed only by a qualified electrician!

1

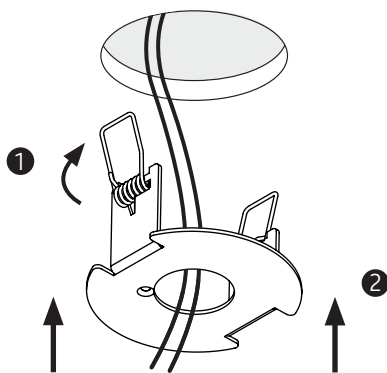

ACHTUNG: Polarität beachten!
CAUTION: Ensure correct polarity!

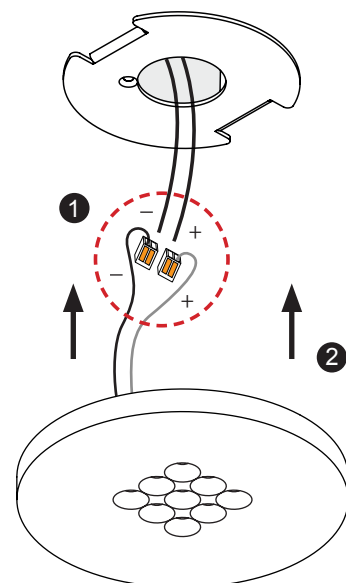

24 V DC
weiss = Plus
schwarz = Minus
white = plus
black = minus

2

3

MODUL R 9

MODUL R 9: 010-389 . 006-415 . 010-391
833.66.337 . 833.66.107 . 833.66.339

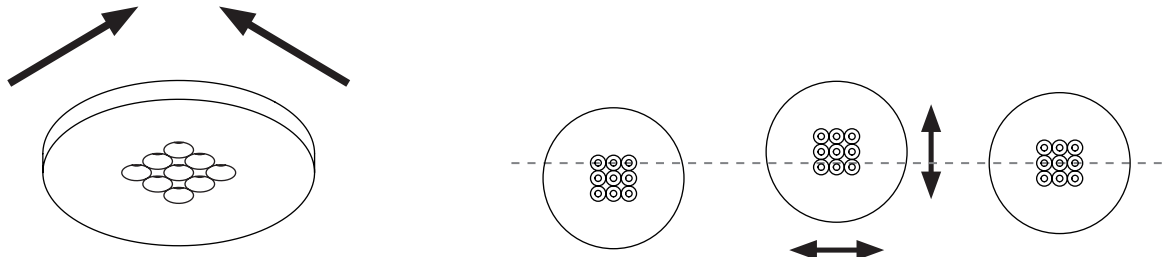

NIMBUS R 9 SERIE

Deckenring für **Hohlraumbau** / bracket for **cavity mounting**

ABMESSUNGEN / SIZES

007-404

