

# RIM R 36

Deckenleuchte / ceiling-mounted luminaire

## MONTAGE / MOUNTING

nimbus<sup>x</sup>

### Deckenauslass stromlos schalten !

Die mitgelieferten Silikonschläuche auf die Länge X kürzen und jeweils einen über die Einzeladern N und L schieben. Eventuell vorhandenen PE-Leiter isolieren und im Gehäuse unterbringen !

### Disconnect ceiling outlet from mains !

Shorten the silicone sleeves supplied to a length of X and place one over the individual wires marked N and L. Insulate possible PE-wire and place it inside of the housing !

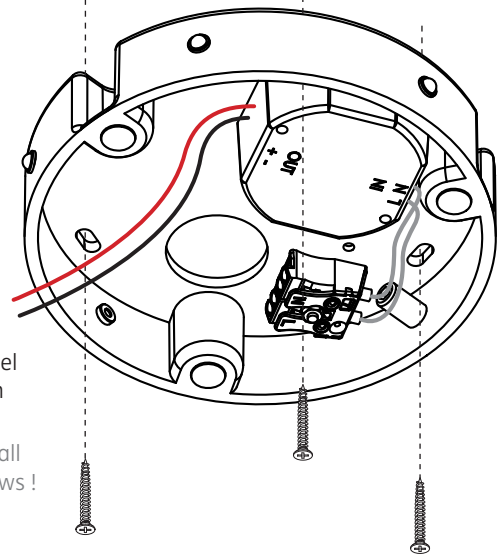
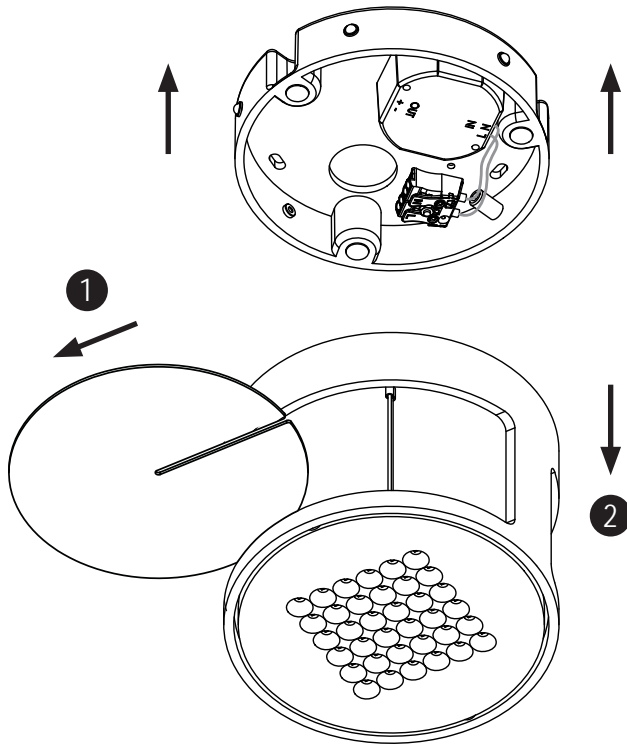
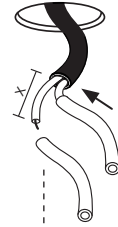

Geeignete Dübel und Schrauben verwenden !  
Use suitable wall plugs and screws !

1

2

Anschluss an 230 V ~  
connection to 230 V AC

Anschluss 24 V DC  
connection with 24 V DC

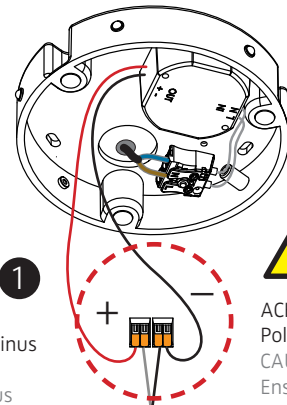
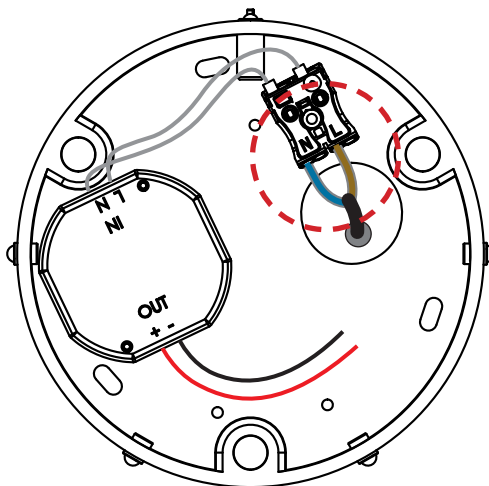

24 V DC  
weiss = Plus  
schwarz = Minus  
white = plus  
black = minus



ACHTUNG:  
Polarität beachten !  
CAUTION:  
Ensure correct polarity !



Montage und Betrieb der Leuchte nur in trockenen Innenräumen.  
Installation and use of luminaire only indoors.



Der elektrische Anschluß darf nur vom Fachmann ausgeführt werden !  
Must be installed by a qualified electrician only !

3

4

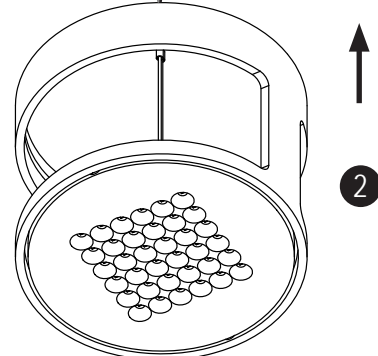

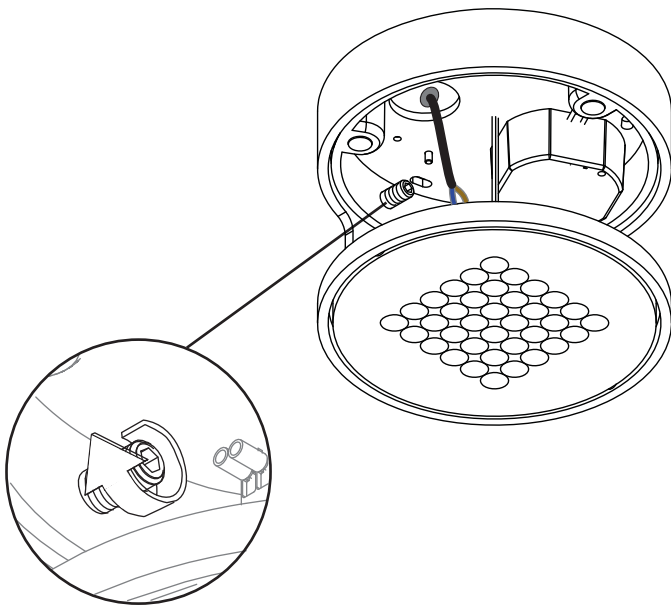

Zur besseren Fixierung des Rohrs die Madenschraube vorsichtig anziehen.  
To improve fixation of the tube tighten the set screw carefully.

5

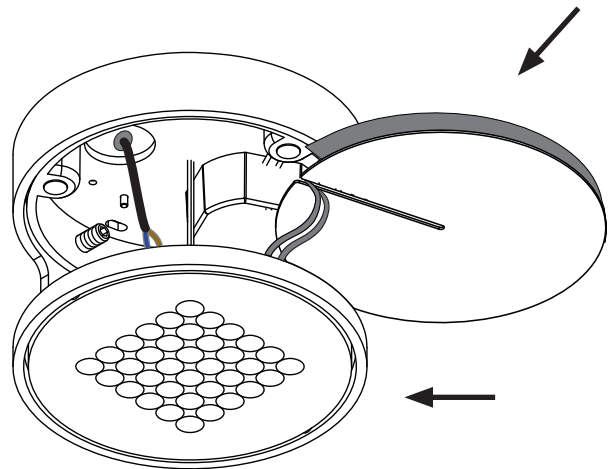

Die auf dem Blech befestigte Isolationsfolie an einer Seite leicht anheben zur besseren Kabeleinführung.  
Lift the fixed isolation sheet for easier positioning of the cables.

6

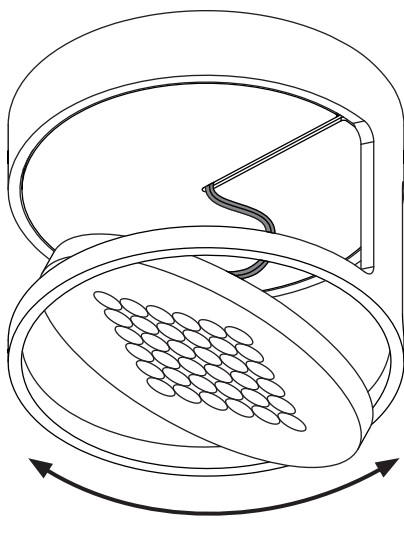

drehbar um 350°  
rotatable up to 350°

schwenkbar um 90°  
tiltable up to 90°

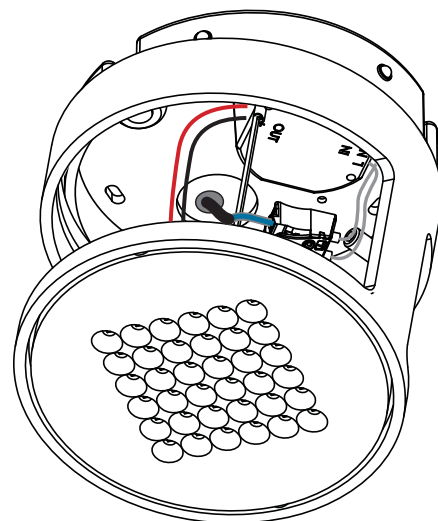

Zur Deinstallation der Leuchte die Madenschraube wieder lösen und das Rohr bis zum Anschlag drehen, dann abziehen.  
To deinstall the luminaire untighten the set screw and turn the tube until the stop. Then pull it off.

7

8

010-201	010-203	545-719	545-718	545-717	545-716	545-715
007-713	008-200	545-723	545-722	545-721	545-720	544-487
010-202	010-204	545-728	545-727	545-726	545-725	545-724

230 V AC / 50 Hz

Leistungsdaten siehe Typenschild!  
Performance data see rating label!



Schutzart IP 20  
protection degree IP 20

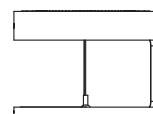

110 mm

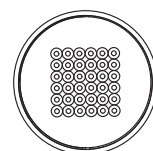

Ø 150 mm



## RIM R 36

DECKENLEUCHTE / CEILING-MOUNTED LUMINAIRE

nimbus<sup>x</sup>

010-201	010-203	545-719	545-718	545-717	545-716	545-715
007-713	008-200	545-723	545-722	545-721	545-720	544-487
010-202	010-204	545-728	545-727	545-726	545-725	545-724

## BOHRSCHABLONE / DRILLING TEMPLATE

ACHTUNG: Zeichnung nicht maßstäblich ! / CAUTION: Template is not drawn to scale !

