

NIMBUS 36 / 49 / 64 SERIE

Deckenring für **Direktmontage** / ceiling ring for **direct mounting**

nimbus^x

MONTAGE / MOUNTING

002-383
833.66.003



Montage und Betrieb nur in Innenräumen!
Mounting and use of luminaire only indoors!

- (A)** Direktmontage in abgehängter Decke
direct mounting in a suspended ceiling

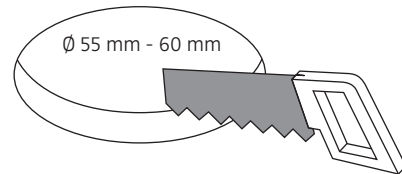
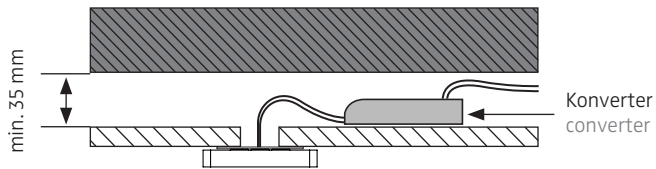

- (B)** für Hohlraumeinbau in poröse Materialien mit geeigneter Hohlraumdose
for installation in porous materials with suitable ceiling junction box

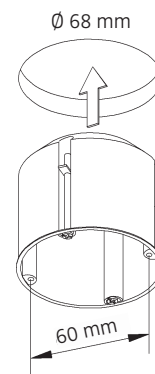
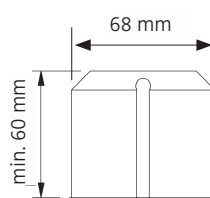
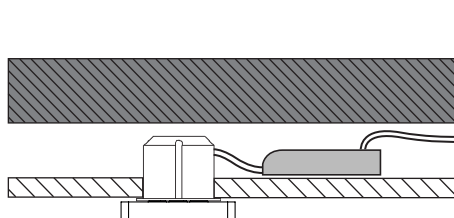

- (C)** für Unterputz / Mauerwerk mit geeigneter Decken-Verbindungsdose
for brick / hollow blocks with suitable ceiling junction box

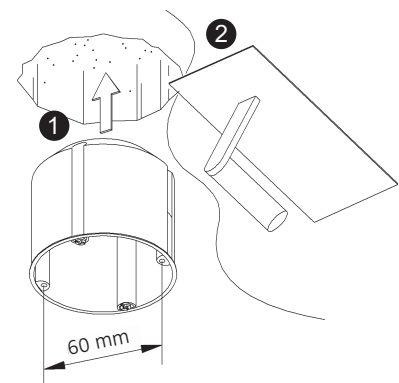
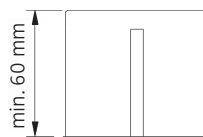
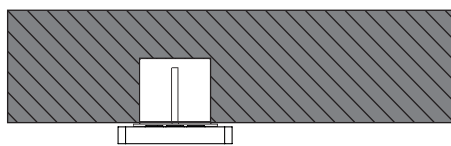

- (D)** Montage in Decken-Verbindungsdose für Beton (z.B. Spelsberg U71)
installation in ceiling junction box for concrete (e.g. Spelsberg U71)

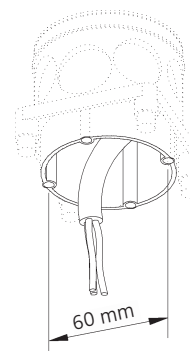
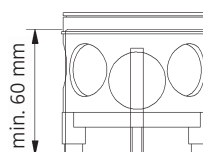
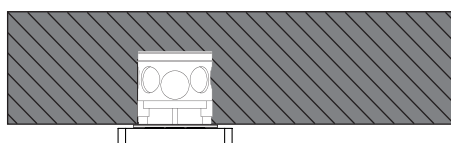

Anschluss mit 230 V ~
connection to 230 V AC



Eventuell vorhandenen Schutzleiter (PE) isolieren und in abgehängter Decke unterbringen!
Insulate possible PE-wire and place it inside of the suspended ceiling!

Zubehör: Konverter (sekundär 24 V DC)
SELV muss bereitgestellt werden!
accessory: converter (output 24 V DC)
SELV must be provided!

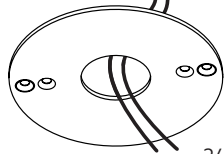

24 V DC

Anschluss an 24 V DC
connection to 24 V DC

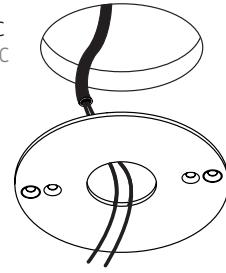

24 V DC **SELV muss bereitgestellt werden!**
SELV must be provided!



Der elektrische Anschluss darf nur vom Fachmann ausgeführt werden!
Must be installed only by a qualified electrician!

1

Senkkopfschrauben müssen plan mit dem Deckenring abschließen!
The countersunk bolts must be on one level with the mounting ring!

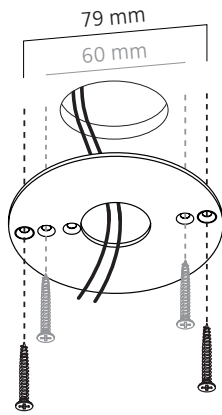

2



ACHTUNG: Polarität beachten!
CAUTION: Ensure correct polarity!

1

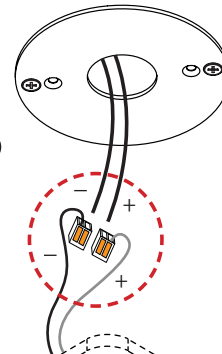

24 V DC
weiss = Plus
schwarz = Minus
white = plus
black = minus

2

MODUL Q

MODUL Q 36: 009-979 . 004-155 . 009-980
833.66.199 . 833.66.038 . 833.66.200
MODUL Q 49: 010-041 . 006-143 . 010-058
833.66.229 . 833.66.096 . 833.66.230
MODUL Q 64: 010-073 . 004-180 . 010-074
833.66.241 . 833.66.041 . 833.66.242

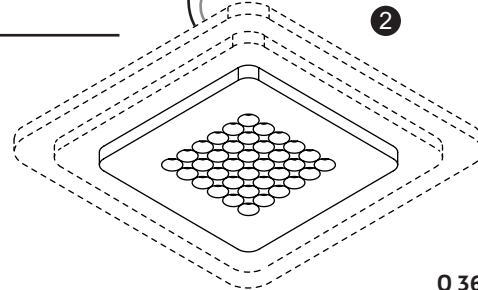

Q 36 / 49 / 64

MODUL R

MODUL R 36: 010-233 . 006-361 . 010-236
833.66.297 . 833.66.101 . 833.66.298
MODUL R 49: 010-348 . 006-362 . 010-349
833.66.315 . 833.66.102 . 833.66.316
MODUL R 64: 010-369 . 006-363 . 010-370
833.66.325 . 833.66.103 . 833.66.326

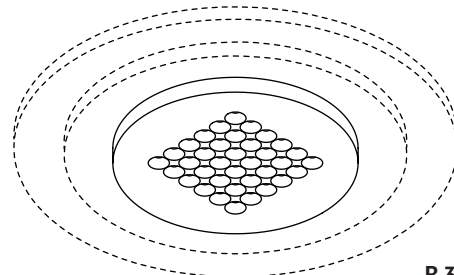

R 36 / 49 / 64

CUBIC

Leuchtenkopf / luminaire head

CUBIC 36: 555-517 . 555-518 . 555-519
833.66.782 . 833.66.783 . 833.66.784
CUBIC 49: 555-780 . 555-781 . 555-782
833.66.821 . 833.66.822 . 833.66.823
CUBIC 64: 555-789 . 555-790 . 555-791
833.66.824 . 833.66.825 . 833.66.826

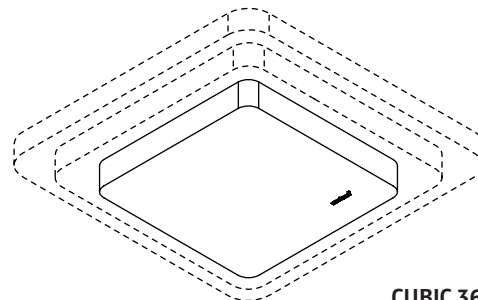

CUBIC 36 / 49 / 64

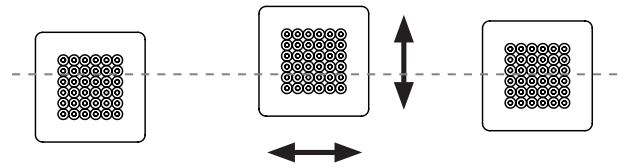
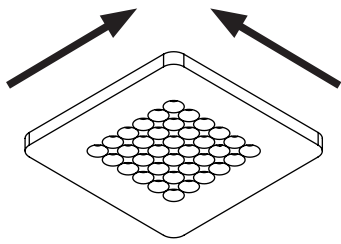

(MODUL Q 36 als Beispiel / MODUL Q 36 as an example)

4

NIMBUS 36 / 49 / 64 SERIE

Deckenring für **Direktmontage** / ceiling ring for **direct mounting**

ABMESSUNGEN / SIZES

002-383
833.66.003

24 V DC Konstantspannung
24 V DC constant voltage

Leistungsdaten siehe Typenschild !
Performance data see rating label !

Schutzart IP 20
protection degree IP 20

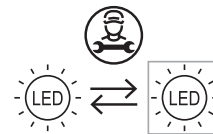
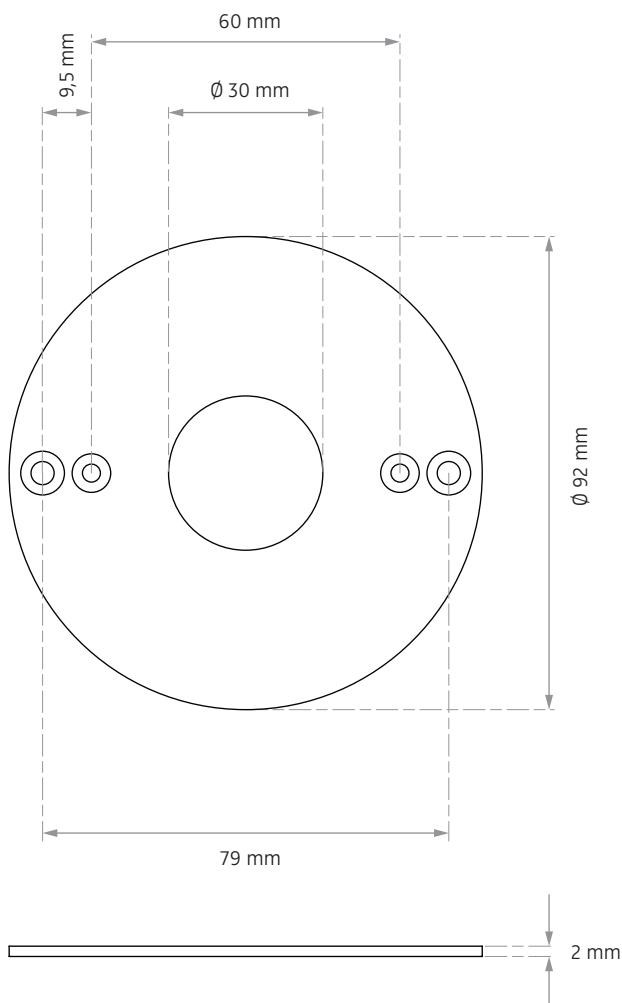

Die Lichtquelle dieser Leuchte darf nur durch den Hersteller oder einen von ihm beauftragten Servicetechniker oder eine vergleichbar qualifizierte Person ersetzt werden !
The light source of this luminaire must only be replaced by the manufacturer, his service representative or any similar qualified person !



Am Ende seiner Lebensdauer darf dieses Produkt nicht mit dem Hausmüll entsorgt werden. Bringen Sie es bitte zu einer kommunalen Sammelstelle für elektrische und elektronische Altgeräte. Nach dem Elektrogesetz muss auch der Handel alte Elektrogeräte zurücknehmen. Richtlinie 2012/19/EU (WEEE-Richtlinie)
This product must not be disposed of with the household refuse at the end of its life cycle. Take it to your local disposal centre for electrical and electronic waste. According to the Electrical and Electronic Equipment Act, the trade must also take back old electrical appliances: Directive 2012/19/EU (WEEE Directive)