

MODUL Q 220 PROJECT

Deckenleuchte für Direktmontage / ceiling luminaire for direct mounting

nimbus^x

MONTAGE / MOUNTING

552-492 . 552-496 / 833.66.654 . 833.66.655



Montage und Betrieb nur in Innenräumen!
Mounting and use of luminaire only indoors!

- A** Direktmontage in abgehängter Decke
direct mounting in a suspended ceiling

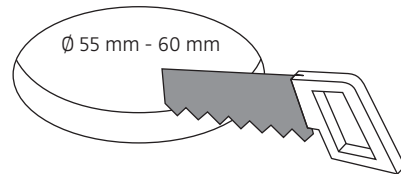
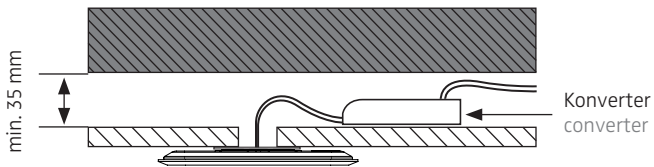

- B** für Hohlraumbau in poröse Materialien mit geeigneter Hohlraumdose
for installation in porous materials with suitable ceiling junction box

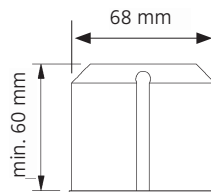
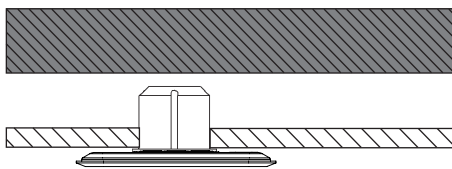

- C** für Unterputz / Mauerwerk mit geeigneter Decken-Verbindungsdose
for brick / hollow blocks with suitable ceiling junction box

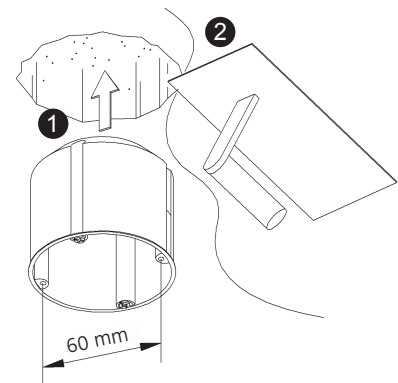
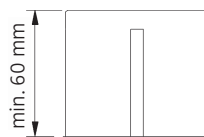
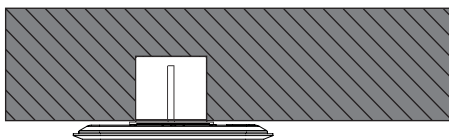

- D** Montage in Decken-Verbindungsdose für Beton (z.B. Spelsberg U71)
installation in ceiling junction box for concrete (e.g. Spelsberg U71)

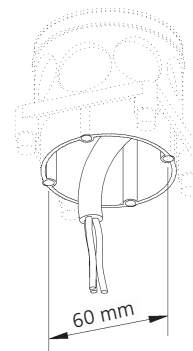
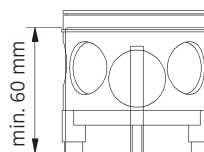
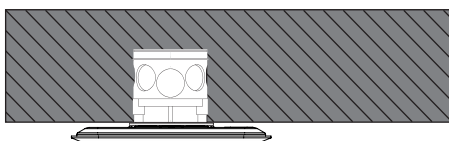

Anschluss mit 230 V ~
connection to 230 V AC

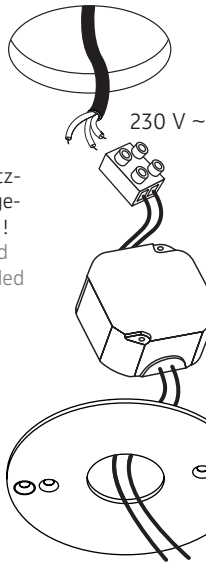

Eventuell vorhandenen Schutzleiter isolieren und in der abgehängten Decke unterbringen!
Insulate possible PE-wire and place it inside of the suspended ceiling!

Zubehör: Konverter (sekundär 24 V DC)
SELV muss bereitgestellt werden!
accessories: converter (output 24 V DC)
SELV must be provided!

Anschluss an 24 V DC
connection to 24 V DC

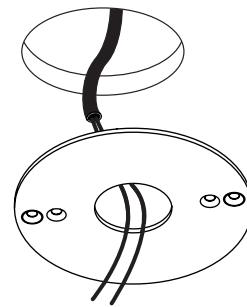

24 V DC (**SELV muss bereitgestellt werden!**)
24 V DC (**SELV must be provided!**)



Der elektrische Anschluss darf nur vom Fachmann ausgeführt werden!
Must be installed by a qualified electrician only!

1

Senkkopfschrauben müssen plan mit dem Deckenring abschließen!
The countersunk bolts must be on one level with the mounting ring!

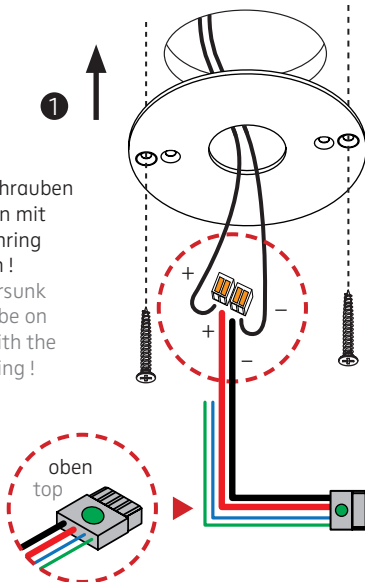

ACHTUNG: Polarität beachten!
CAUTION: Ensure correct polarity!

Stecker einführen, grüner Punkt oben!
Insert plug, green dot on top!

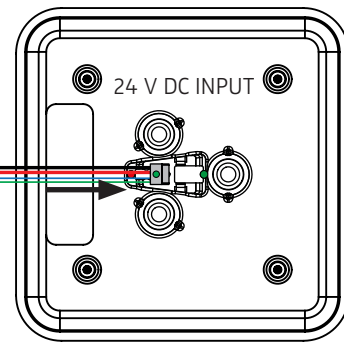

24 V DC
rot = Plus
schwarz = Minus
red = plus
black = minus
grün, blau = nicht belegt
green, blue = not assigned



ACHTUNG: Leuchte NICHT an der Zuleitung hängen lassen. Zum Lösen der 24 V-Steckverbindung NUR horizontal in Richtung des Kabels ziehen!
CAUTION: Do NOT suspend luminaire from this supply cord. To detach the 24 V connection ONLY pull horizontally in the direction of the cable!

2

3

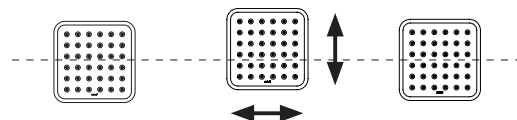
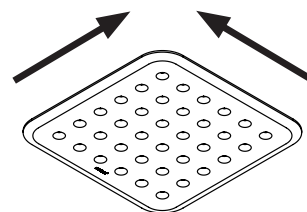
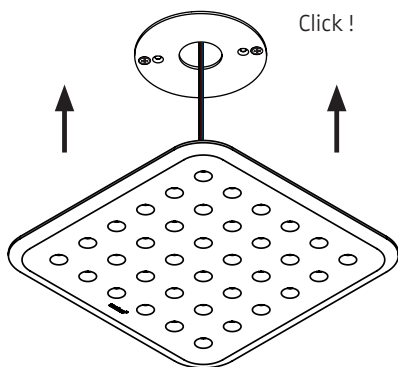

4

5

552-492 . 552-496
833.66.654 . 833.66.655

Schutzart IP 20
protection degree IP 20



24 V DC Konstantspannung
24 V DC constant voltage



Schutzklasse III / Betrieb mit Schutzkleinspannung (SELV)
IEC protection class III / device operated with SELV

Leistungsdaten siehe Typenschild!
Performance data see rating label!

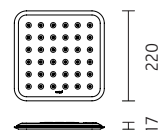

MODUL Q 220 PROJECT

Deckenleuchte für Direktmontage / ceiling luminaire for direct mounting

nimbus^x

552-492 . 552-496 / 833.66.654 . 833.66.655

Am Ende seiner Lebensdauer darf dieses Produkt nicht mit dem Hausmüll entsorgt werden. Bringen Sie es bitte zu einer kommunalen Sammelstelle für elektrische und elektronische Altgeräte. Nach dem Elektroggesetz muss auch der Handel alte Elektrogeräte zurücknehmen. Richtlinie 2012/19/EU (WEEE-Richtlinie)

This product must not be disposed of with the household refuse at the end of its life cycle. Take it to your local disposal centre for electrical and electronic waste.

According to the Electrical and Electronic Equipment Act, the trade must also take back old electrical appliances: Directive 2012/19/EU (WEEE Directive)

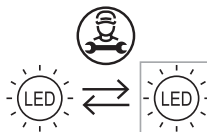

Die Lichtquelle dieser Leuchte darf nur durch den Hersteller oder einen von ihm beauftragten Servicetechniker oder eine vergleichbar qualifizierte Person ersetzt werden !

The light source of this luminaire must only be replaced by the manufacturer, his service representative or any similar qualified person !

DECKENMONTAGERING FÜR MODUL Q PROJECT 220 / 280 / 340

CEILING MOUNTING RING FOR MODUL Q PROJECT 220 / 280 / 340

