

# MODUL R 280 PROJECT AUFBAU DALI

Deckenaufbauleuchte für Direktmontage, dimmbar über DALI/switchDim  
surface mounted ceiling luminaire for direct mounting, dimmable via DALI/switchDim

nimbus<sup>x</sup>

## MONTAGE / MOUNTING

552-959 . 552-961 / 833.66.691 . 833.66.692



Montage und Betrieb nur in Innenräumen!  
Mounting and use of luminaire only indoors!

- A** Direktmontage in abgehängter Decke  
direct mounting in a suspended ceiling

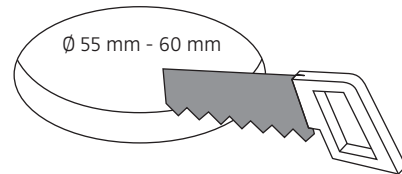
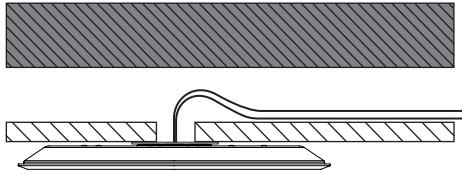

- B** für Hohlraumeinbau in poröse Materialien mit geeigneter Hohlraumdose  
for installation in porous materials with suitable ceiling junction box

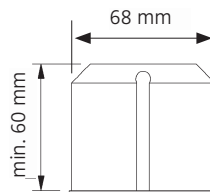
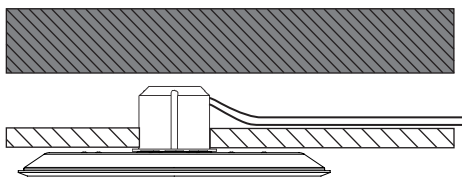

- C** für Unterputz / Mauerwerk mit geeigneter Decken-Verbindungsdose  
for brick / hollow blocks with suitable ceiling junction box

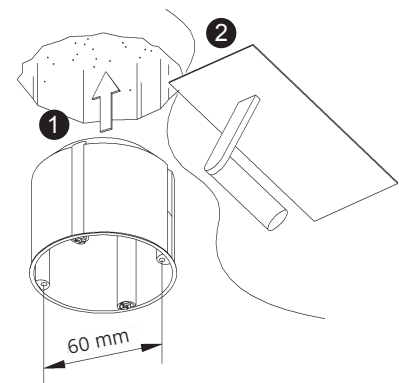
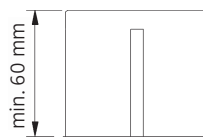
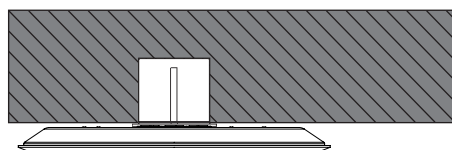

- D** Montage in Decken-Verbindungsdose für Beton (z.B. Spelsberg U71)  
installation in ceiling junction box for concrete (e.g. Spelsberg U71)

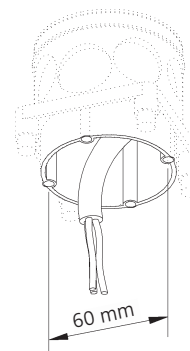
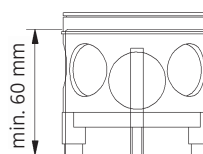
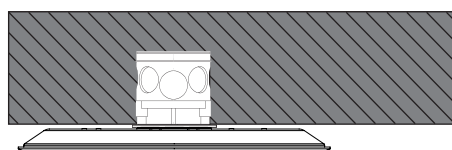

Anschluss an 230 V ~ / connection to 230 V AC

**Deckenauslass stromlos schalten !**

Die mitgelieferten Silikonschläuche auf die Länge X kürzen und jeweils einen über die Einzeladern N und L (optional auch über die Steuerleitungen vom Taster) schieben. Dadurch wird eine Verdrachtung gemäß Schutzklasse II sichergestellt. Eventuell vorhandenen Schutzleiter (PE) isolieren und im Anschlussraum unterbringen.

**Disconnect ceiling outlet from mains !**

Shorten the silicone sleeves supplied to a length of X and place one over the individual wires marked N and L (over optional control wires from push button as well). This ensures protection class II. Insulate possible PE-wire and place it in the connection area on top of the luminaire.

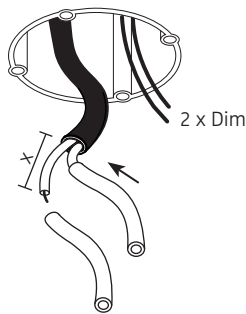

Doppelten Deckenring nicht trennen !  
Do not separate double ceiling ring !

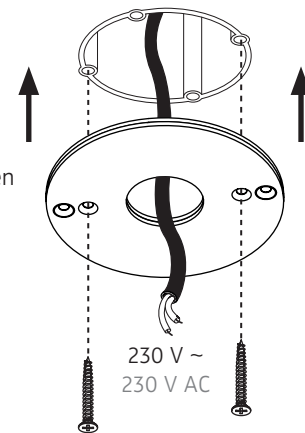

Senkkopfschrauben müssen plan mit dem Deckenring abschließen !

The countersunk bolts must be on a level with the mounting ring !

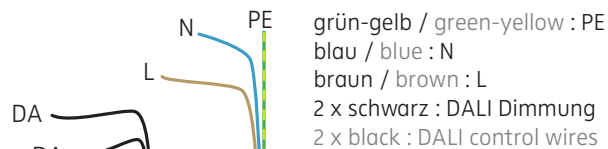

Der elektrische Anschluss darf nur vom Fachmann ausgeführt werden !  
Must be installed by a qualified electrician only !

1

2

Anschluss an 230 V ~ und DALI-Signal / Taster-Signal  
connection to 230 V AC and DALI signal / push button signal

PE = grün-gelb  
green-yellow  
N = blau / blue  
L = braun / brown

2 x schwarz = DALI-Signal  
2 x black = DALI signal

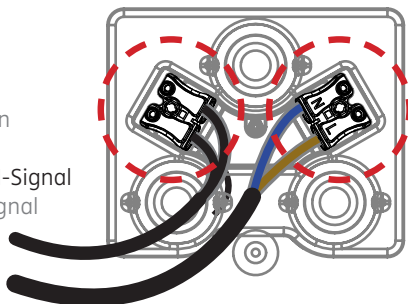

Phase vom Netzspannungstaster  
live wire from push button (mains)  
Brücke Null-Leiter (N)  
bridged neutral (N)

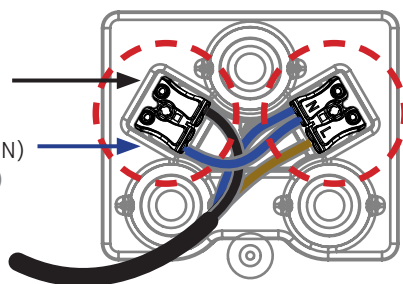

1

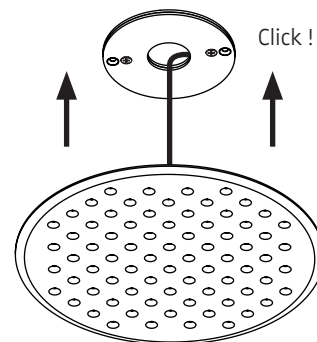

2

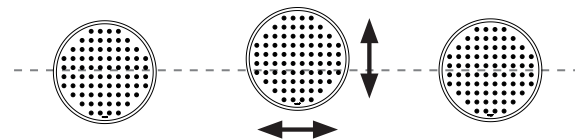

3

4

552-959 . 552-961  
833.66.691 . 833.66.692

Schutzart IP 20  
protection degree IP 20



230 V ~ / 50 Hz  
230 V AC / 50 Hz



Schutzklasse II / doppelte Isolierung  
protection class II / double insulation

Leistungsdaten siehe Typenschild !  
Performance data see rating label !

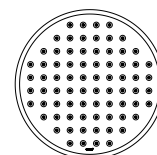

340



27

# MODUL R 280 PROJECT AUFBAU DALI

Deckenaufbauleuchte für Direktmontage, dimmbar über DALI/switchDim  
surface-mounted ceiling luminaire for direct mounting, dimmable via DALI/switchDim

552-959 . 552-961 / 833.66.691 . 833.66.692

Am Ende seiner Lebensdauer darf dieses Produkt nicht mit dem Hausmüll entsorgt werden. Bringen Sie es bitte zu einer kommunalen Sammelstelle für elektrische und elektronische Altgeräte. Nach dem Elektroggesetz muss auch der Handel alte Elektrogeräte zurücknehmen. Richtlinie 2012/19/EU (WEEE-Richtlinie)

This product must not be disposed of with the household refuse at the end of its life cycle. Take it to your local disposal centre for electrical and electronic waste.

According to the Electrical and Electronic Equipment Act, the trade must also take back old electrical appliances: Directive 2012/19/EU (WEEE Directive)

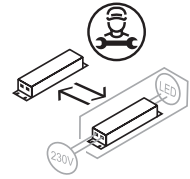
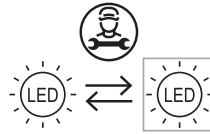

Die Lichtquelle oder das Betriebsgerät dieser Leuchte darf nur durch den Hersteller oder einen von ihm beauftragten Servicetechniker oder eine vergleichbar qualifizierte Person ersetzt werden !

The light source or the operating device of this luminaire must only be replaced by the manufacturer, his service representative or any similar qualified person !

## DECKENMONTAGERING FÜR MODUL Q PROJECT 220 / 280 / 340 DALI

CEILING MOUNTING RING FOR MODUL Q PROJECT 220 / 280 / 340 DALI

