

MODUL R 280 PROJECT AUFBAU CASAMBI

Deckenaufbauleuchte für Direktmontage mit Bluetooth-Steuerung
surface-mounted ceiling luminaire for direct mounting with Bluetooth Control

nimbus^x

MONTAGE / MOUNTING

552-965 . 552-967 / 833.66.695 . 833.66.696



Montage und Betrieb nur in Innenräumen!
Mounting and use of luminaire only indoors!

- A** Direktmontage in abgehängter Decke
direct mounting in a suspended ceiling

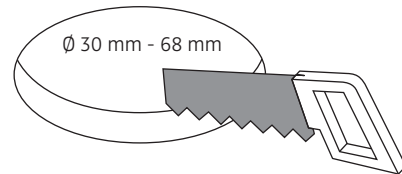
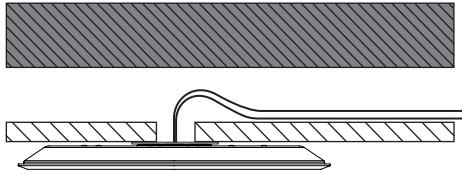

- B** für Hohlraumeinbau in poröse Materialien mit geeigneter Hohlraumdose
for installation in porous materials with suitable ceiling junction box

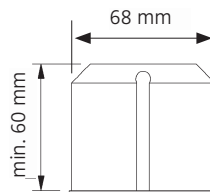
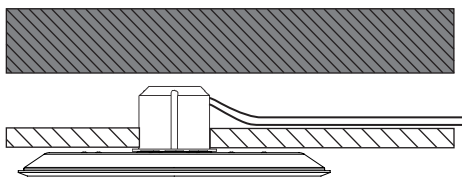

- C** für Unterputz / Mauerwerk mit geeigneter Decken-Verbindungsdose
for brick / hollow blocks with suitable ceiling junction box

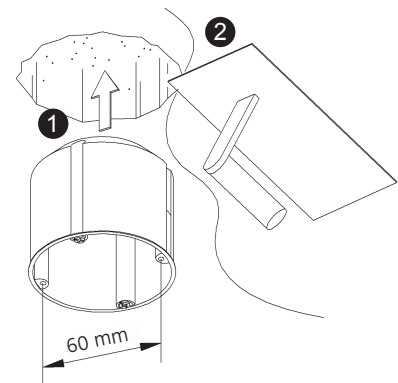
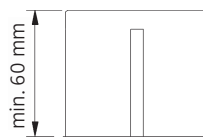
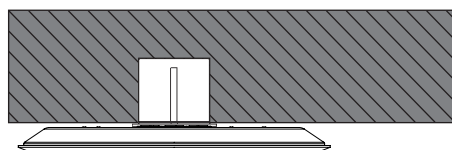

- D** Montage in Decken-Verbindungsdose für Beton (z.B. Spelsberg U71)
installation in ceiling junction box for concrete (e.g. Spelsberg U71)

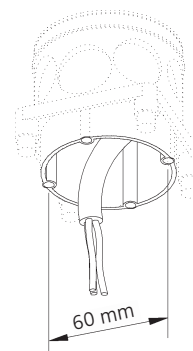
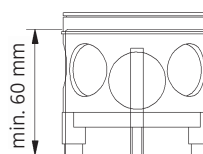
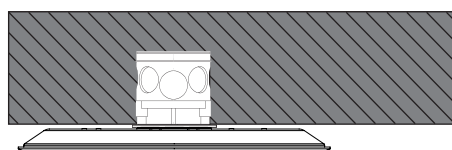

Anschluss an 230 V ~
connection to 230 V AC

**Deckenauslass
 stromlos schalten !**
**Disconnect ceiling
 outlet from mains !**

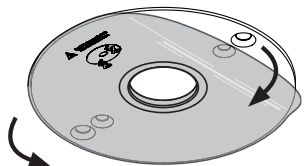

Folie vorsichtig anheben !
 Lift foil carefully !

2 x

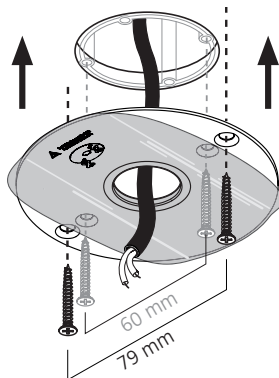

Folie NICHT verletzen oder entfernen !
 Do NOT damage or remove the foil !

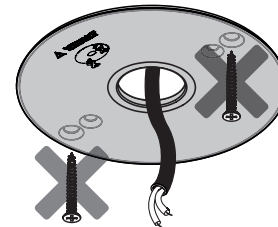

Senkkopfschrauben
 müssen plan mit
 dem Deckenring
 abschließen !
 The countersunk
 bolts must be on a
 level with the
 mounting ring !

1

2

3



Der elektrische Anschluss darf nur vom
 Fachmann ausgeführt werden !
 Must be installed by a qualified electrician only !

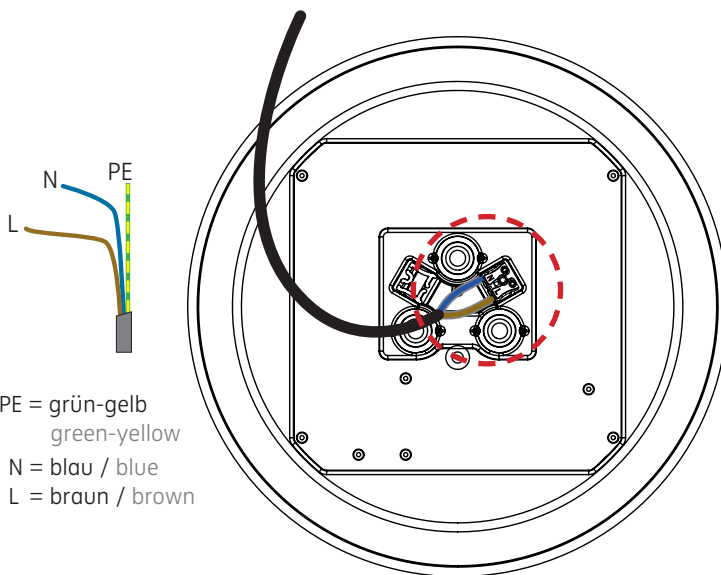

PE = grün-gelb
 green-yellow
 N = blau / blue
 L = braun / brown

1

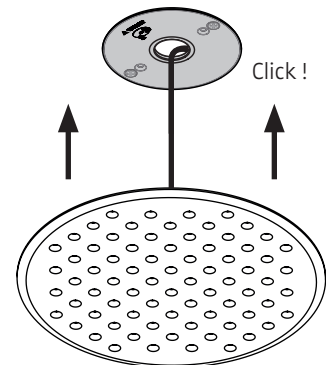

2

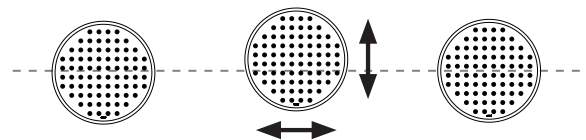

Eventuell vorhandenen Schutzleiter isolieren
 und im Anschlussraum unterbringen !
 Insulate possible PE-wire and place it in the
 connection area on top of the luminaire !

4

5

552-965 . 552-967
 833.66.695 . 833.66.696

230 V ~ / 50 Hz
 230 V AC / 50 Hz

Leistungsdaten siehe Typenschild !
 Performance data see rating label !

Schutzart IP 20
 protection degree IP 20



Schutzklasse II / doppelte Isolierung
 protection class II / double insulation

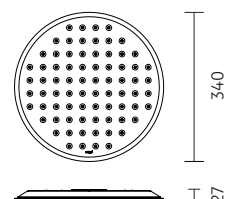

MODUL R 280 PROJECT AUFBAU CASAMBI

Deckenaufbauleuchte für Direktmontage mit Bluetooth-Steuerung
surface-mounted ceiling luminaire for direct mounting with Bluetooth Control

nimbus^x

552-965 . 552-967 / 833.66.695 . 833.66.696

Am Ende seiner Lebensdauer darf dieses Produkt nicht mit dem Hausmüll entsorgt werden. Bringen Sie es bitte zu einer kommunalen Sammelstelle für elektrische und elektronische Altgeräte. Nach dem Elektroggesetz muss auch der Handel alte Elektrogeräte zurücknehmen. Richtlinie 2012/19/EU (WEEE-Richtlinie)

This product must not be disposed of with the household refuse at the end of its life cycle. Take it to your local disposal centre for electrical and electronic waste.

According to the Electrical and Electronic Equipment Act, the trade must also take back old electrical appliances: Directive 2012/19/EU (WEEE Directive)

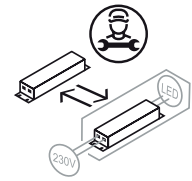
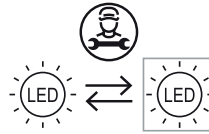

Die Lichtquelle oder das Betriebsgerät dieser Leuchte darf nur durch den Hersteller oder einen von ihm beauftragten Servicetechniker oder eine vergleichbar qualifizierte Person ersetzt werden !

The light source or the operating device of this luminaire must only be replaced by the manufacturer, his service representative or any similar qualified person !

MODUL R PROJECT 220 / 280 / 340
MODUL R PROJECT 220 / 280 / 340

Deckenring für **Direktmontage mit 230 V ~**
ceiling ring for **direct mounting with 230 V AC**

562-812 / 833.67.648

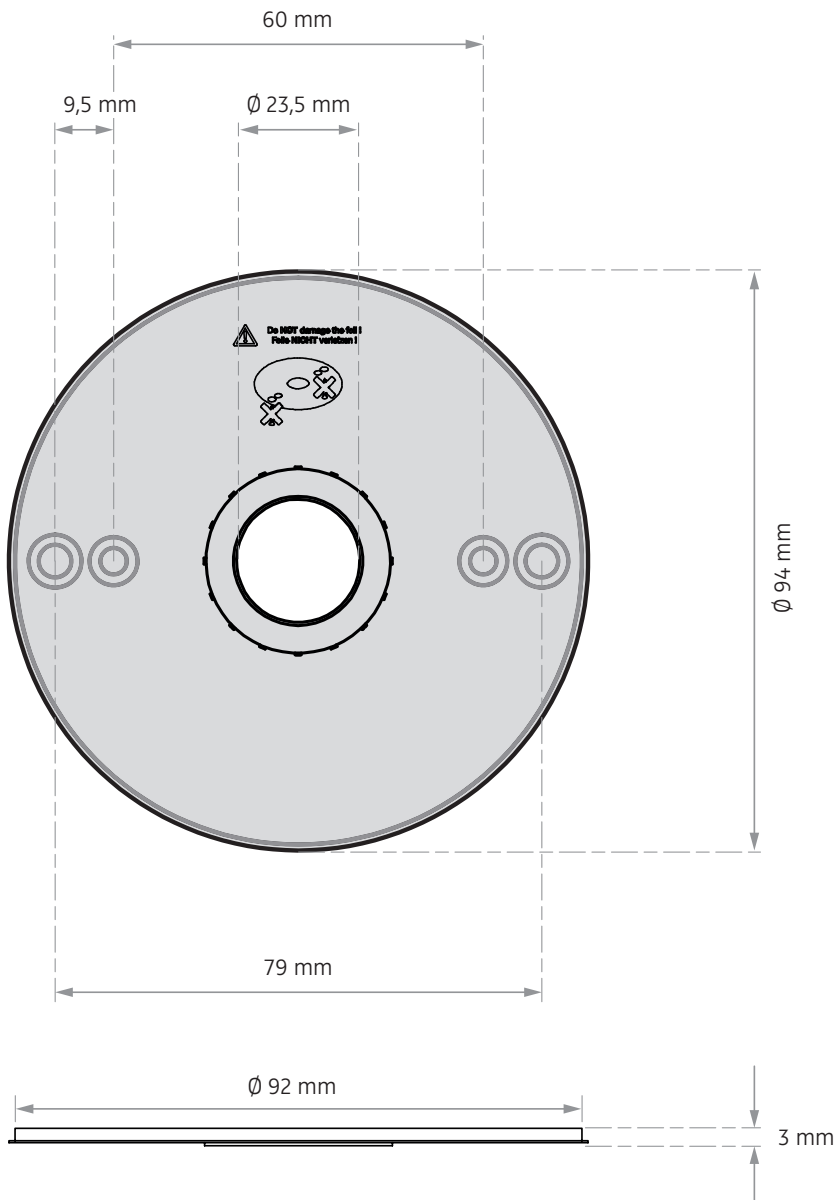

HINWEIS:

Die CASAMBI Bedienungsanleitung finden Sie auf unserer Website unter: **Service > Downloads > Bedienungsanleitungen > Quick-Start-Guide Light Control.**

Als Alternative können Sie auch diesen QR-Code mit Ihrem Smartphone scannen.



NOTE:

You will find the instruction manual for CASAMBI here on our website:

Service > Downloads > Manuals > Quick-Start-Guide Light Control.

Alternatively you can scan the QR code with your smart phone.