

DATENBLATT / FACT SHEET



ART.-NR:	FARBTEMPERATUR:
546-912	2700 K
545-478	3000 K
546-913	4000 K

MARIE 49

DECKENLEUCHE / CEILING-MOUNTED LUMINAIRE

Extrem flache, nur 10 mm hohe LED.next Deckenleuchte für Direktmontage, Lichtaustritt vorwiegend (ca. 95 %) direktstrahlend, breit abstrahlend, zusätzliche Deckenaufhellung sowie sehr gleichmäßige, nahezu raumhohe Wandaufhellung durch Sekundärlicht, externer Nimbus-Konverter erforderlich, dieser kann in die abgehängte Decke bzw. in die Decken-Verbindungsdose integriert werden, die Leuchte kann direkt an dieser Decken-Verbindungsdose befestigt werden.

11 W LED.next ≈ 70 W Halogen

Ultra-flat LED.next ceiling-mounted luminaire (10 mm material thickness only) for direct mounting, beam mainly direct (approx. 95 %), wide beam, additional ceiling lighting and also a very even, almost floor-to-ceiling illumination of walls by secondary light, external Nimbus converter required, the converter can be integrated in a suspended ceiling or an in-ceiling junction box, the luminaire can be directly fastened to this in-ceiling junction box.

11 W LED.next ≈ 70 W halogen

TECHNISCHE DATEN / TECHNICAL FACTS

Artikel:

MARIE 49

Art.-Nr.: **Farbtemperatur:**

546-912 2700 K

545-478 3000 K

546-913 4000 K

Beschreibung/Ausführung:

Deckenleuchte für Direktmontage

Hersteller:

Nimbus Group GmbH
 Sieglestr. 41, D-70469 Stuttgart
 Tel.: +49(0)711 / 63 30 14 - 0
 Fax: +49(0)711 / 63 30 14 - 14
 info@nimbus-group.com
 www.nimbus-group.com

Abmessungen:

Ø 200 x 10 mm

Material:

Diffusorfläche: Acrylglas

Aufhängung: Stahl

Gewicht:

ca. 392 g

Lichttechnik:**LED.next** -Technologie integriert**Anschluss-Leistung:**

11 W / 24 Volt DC / Energieeffizienzklasse A+

Anzahl LEDs:

49 Stück

Schutzart:

IP 20

Lichtstrom:

813 lm

Abstrahlcharakteristik:

breit abstrahlend

Lichtverteilung:

95 % direktstrahlend

RA:

80

Prüfzeichen:**Reinigungs- und Pflegehinweise:**

Leuchte beim Reinigen vom Netz trennen. Keine ätzenden oder abrasiven Reinigungsmittel verwenden. Wir empfehlen, die Leuchte nur mit einem Microfasertuch o. ä. trocken zu reinigen.

Alle Angaben erfolgen ohne Gewähr für Irrtümer und Übertragungsfehler. Wir bitten um Verständnis, dass wir uns Änderungen in der Gestalt und Technik vorbehalten.

product:

MARIE 49

product no. **colour temperature:**

546-912 2700 K

545-478 3000 K

546-913 4000 K

description/design:

ceiling luminaire for direct mounting

manufacturer:

Nimbus Group GmbH
 Sieglestr. 41, D-70469 Stuttgart
 Tel.: +49(0)711 / 63 30 14 - 0
 Fax: +49(0)711 / 63 30 14 - 14
 info@nimbus-group.com
 www.nimbus-group.com

dimensions:

Ø 200 x 10 mm

materials:

diffuser surface: acrylic glass

mounting: steel

weight:

approx. 392 grams

light technology:**LED.next** -technology integrated**required power supply:**

11 W / 24 volts DC / energy efficiency class A+

number of LEDs:

49 pcs

degree of protection:

IP 20

luminous flux:

813 lm

directional characteristics:

wide beam

light distribution:

95 % direct beam

CRI:

80

certificates:**cleaning and care:**

Switch off luminaire while cleaning. Do not use any corrosive or abrasive cleanser. We recommend to clean the luminaire with a dry microfibre towel only.

The information may be subject to errors in content or transmission errors; we do not accept responsibility for any such errors. We reserve the right to make changes to design and technology and apologise for any inconvenience this may cause.

LICHTVERTEILUNGSKURVE UND ABSTRAHLCHARAKTERISTIK LIGHT DISTRIBUTION CURVE AND DIRECTIONAL CHARACTERISTICS

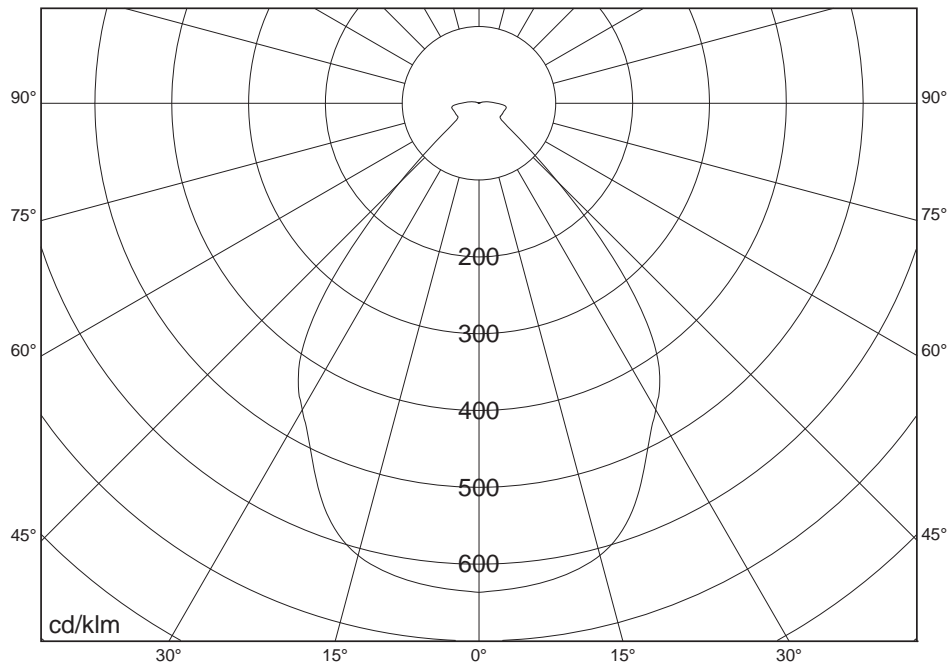

Lichtberechnungsdaten (EULUMDAT) unter www.nimbus-group.com

ISOMETRIE UND MASSE / SIZES

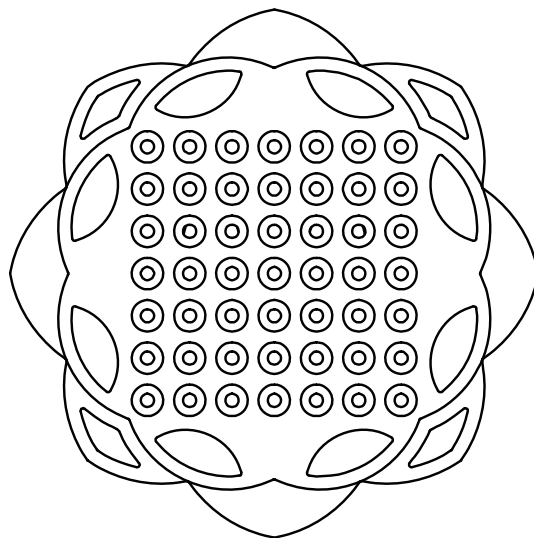
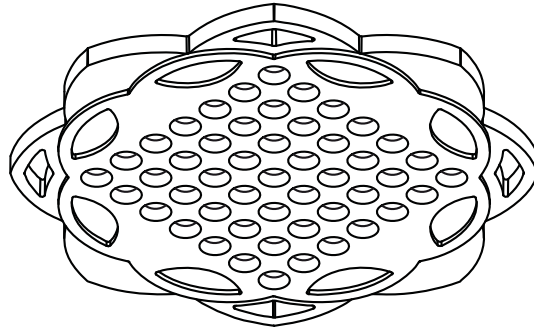

MARIE 49 LED.next

DECKENLEUCTE / CEILING-MOUNTED LUMINAIRE

nimbus^x

546-912 . 545-478 . 546-913 - MONTAGE / MOUNTING

FÜR HOHLRAUMEINBAU / DIREKTMONTAGE (ABGEHÄNGTE DECKE)
FOR PLASTERBOARD / DIRECT MOUNTING (SUSPENDED CEILING)

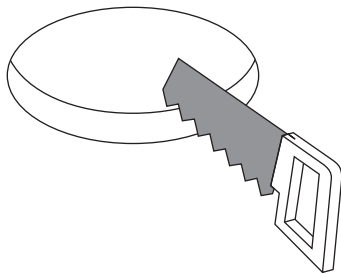
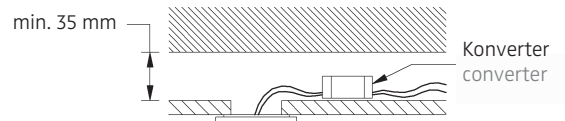

1

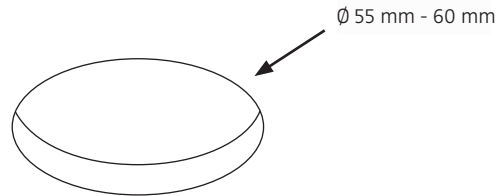

2

Anschluss mit 230 V ~
connection to 230 V AC

Anschluss mit 24 V DC
connection to 24 V DC

Anschluss mit 230 V ~
connection to 230 V AC

Anschluss mit 24 V DC
connection to 24 V DC

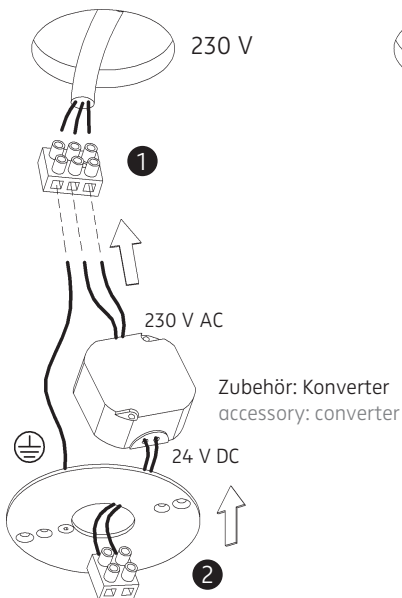

Der elektrische Anschluß darf nur vom Fachmann ausgeführt werden!
Must be installed by a qualified electrician only!

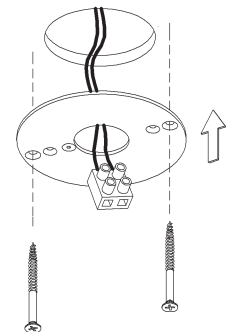
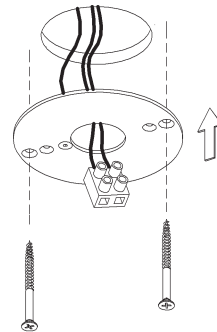

3

4

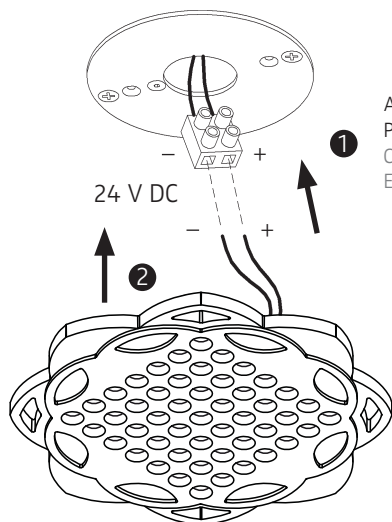

ACHTUNG:
Polarität beachten!
CAUTION:
Ensure correct polarity!

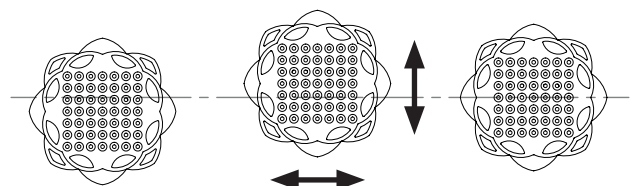
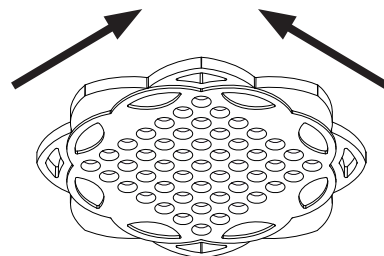

5

6

FÜR HOHLRAUMEINBAU IN PORÖSE MATERIALIEN
FOR INSTALLATION IN POROUS MATERIALS

mit geeigneter Hohlraumdose
with suitable ceiling junction box

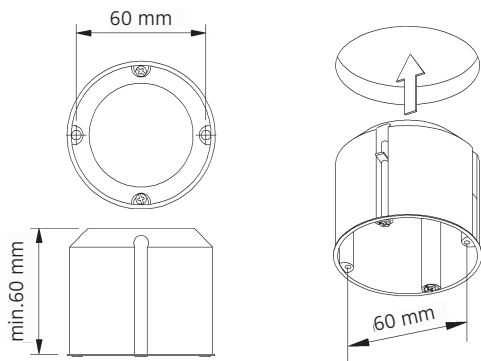
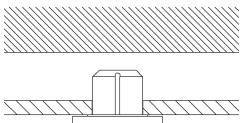

1

Anschluss mit 230 V ~
connection to 230 V AC

Anschluss mit 24 V DC
connection to 24 V DC

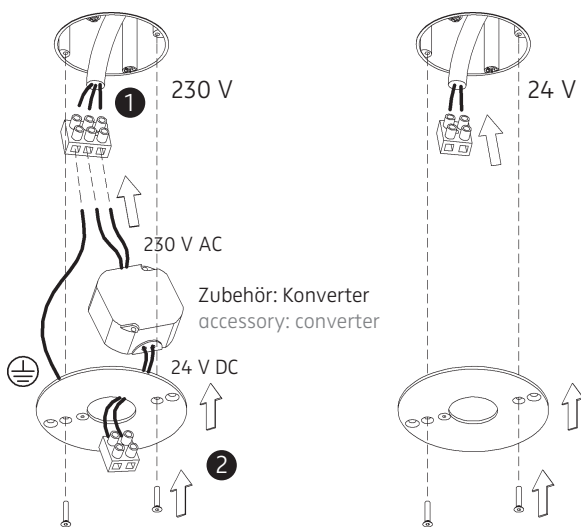

2

FÜR UNTERPUTZ / MAUERWERK
FOR BRICK / HOLLOW BLOCKS

mit geeigneter Decken-Verbindungsdose
with suitable ceiling junction box

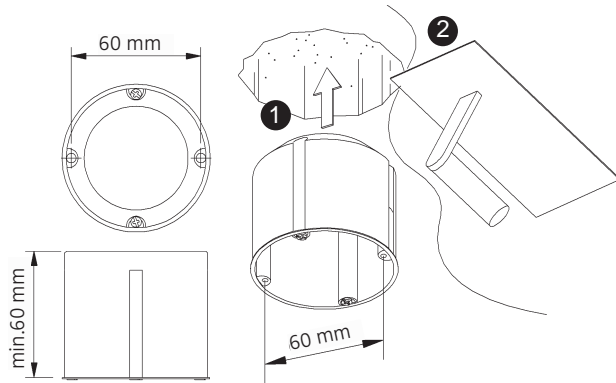
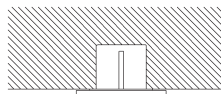

1

ACHTUNG: Beim Einbau von Konvertern in Deckendosen die Planungshinweise auf unserer Homepage beachten!
CAUTION: Keep in mind the planning advice on our homepage when you insert converters into ceiling boxes!



Der elektrische Anschluß darf nur vom Fachmann ausgeführt werden!

Must be installed by a qualified electrician only!

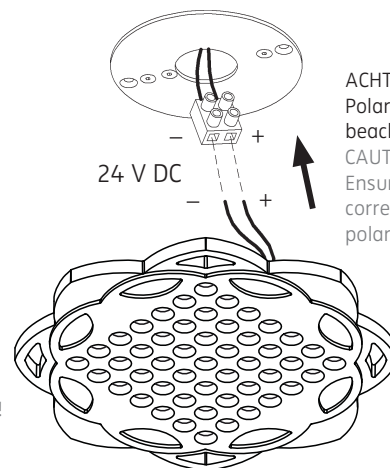

3

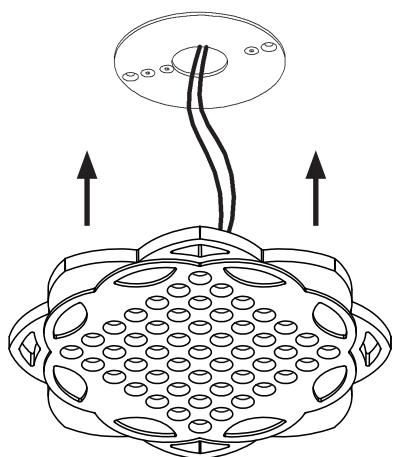

4

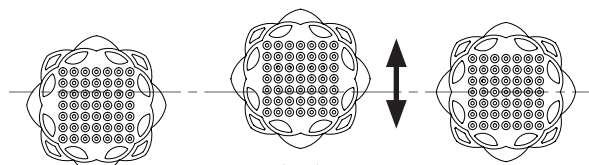
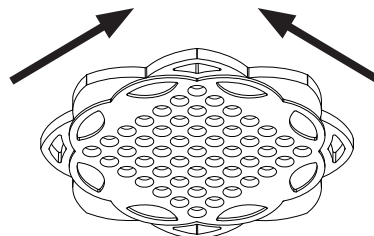

5

MONTAGE IN DECKEN-VERBINDUNGSDOSE FÜR BETON
INSTALLATION IN CEILING JUNCTION BOX FOR CONCRETE
 mit geeigneter Decken-Verbindungsdose, z.B. Spelsberg U71
 with suitable ceiling junction box, e.g. Spelsberg U71

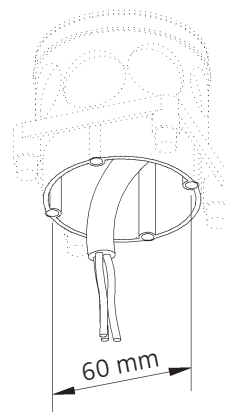
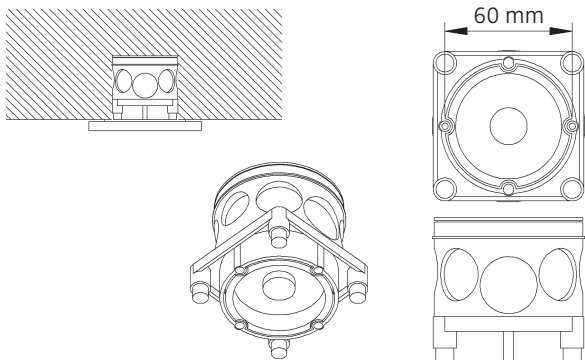

1

Anschluss mit 230 V ~
 connection to 230 V AC

Anschluss mit 24 V DC
 connection to 24 V DC

ACHTUNG: Beim Einbau von Konvertern in Deckendosen die Planungshinweise auf unserer Homepage beachten!
CAUTION: Keep in mind the planning advice on our homepage when you insert converters into ceiling boxes!

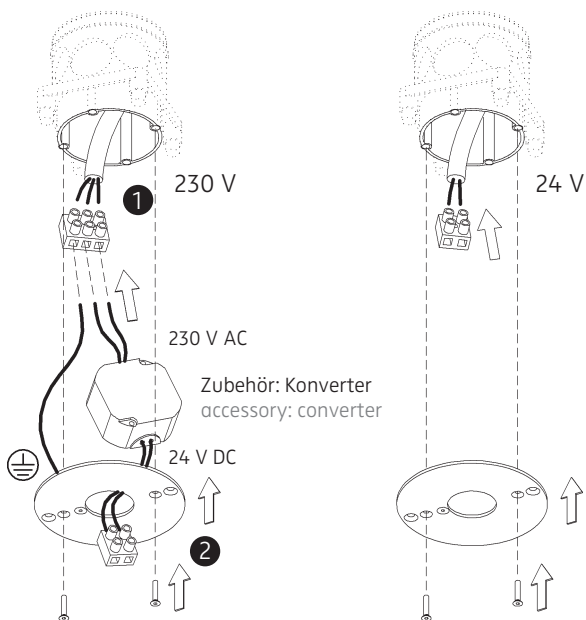

Der elektrische Anschluß darf nur vom Fachmann ausgeführt werden!

Must be installed by a qualified electrician only!

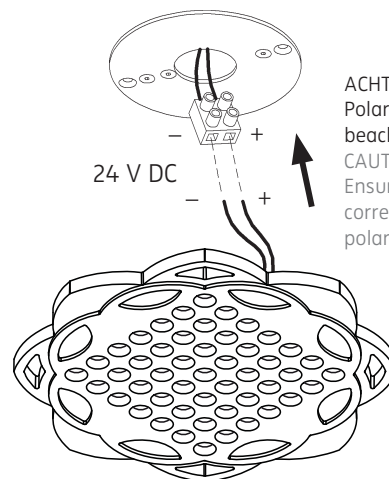

ACHTUNG: Polarität beachten!
CAUTION: Ensure correct polarity!

2

3

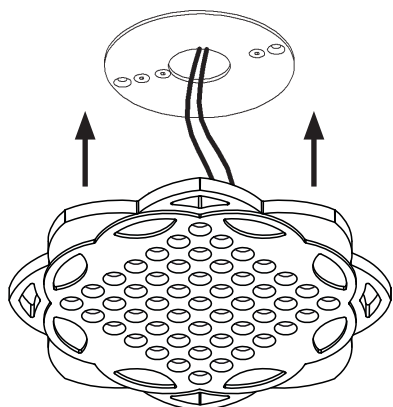

4

5

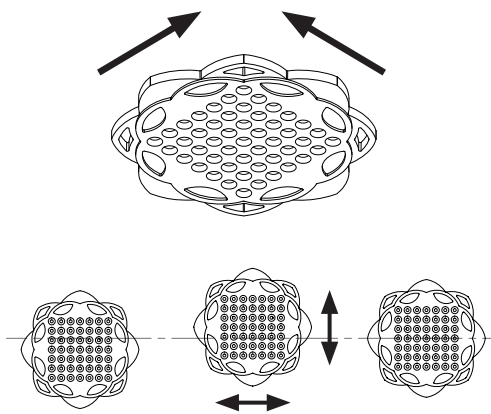

546-912 . 545-478 . 546-913

24 V DC / Bestückung LED.next 11 W
 24 V DC / lamp type LED.next 11 W

Schutzart IP 20
 protection degree IP 20

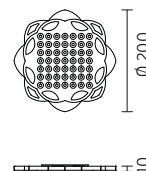

MARIE 49 LED.next

DECKENLEUCHTE / CEILING-MOUNTED LUMINAIRE

546-912 . 545-478 . 546-913

nimbus^x

DECKENMONTAGERING MARIE 36, MARIE 49, MARIE 64

CEILING MOUNTING RING MARIE 36, MARIE 49, MARIE 64

