

NIMBUS Q 9 SERIE

Deckenring für **Direktmontage** / ceiling ring for **direct mounting**

nimbus^x

MONTAGE / MOUNTING

002-877



Montage und Betrieb nur in Innenräumen!
Mounting and use of luminaire only indoors!

A Direktmontage in abgehängter Decke
direct mounting in a suspended ceiling

erforderliche Deckenöffnung
necessary ceiling opening

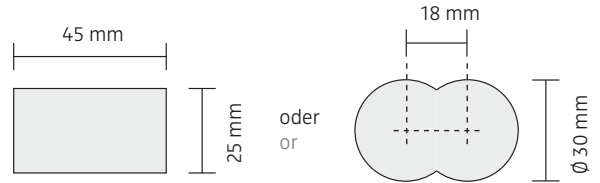
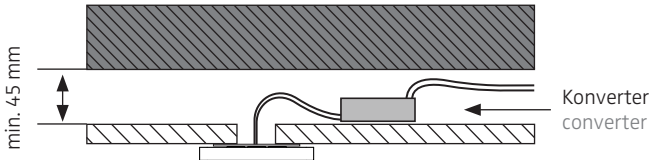

Anschluss mit 230 V ~
connection to 230 V AC

Anschluss an 24 V DC
connection to 24 V DC

Eventuell vorhandenen Schutzleiter (PE) isolieren und in abgehängter Decke unterbringen!
Insulate possible PE-wire and place it inside of the suspended ceiling!

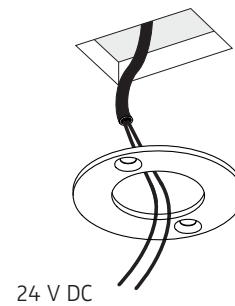
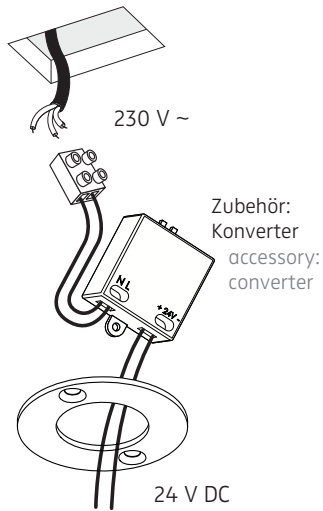

Der elektrische Anschluss darf nur vom Fachmann ausgeführt werden!
Must be installed only by a qualified electrician!

1

Senkkopfschrauben müssen plan mit dem Deckenring abschließen!
The countersunk bolts must be on one level with the mounting ring!

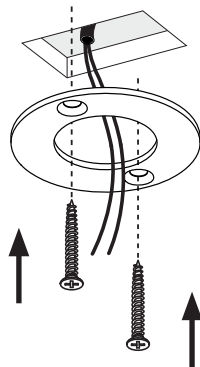

ACHTUNG: Polarität beachten!
CAUTION: Ensure correct polarity!

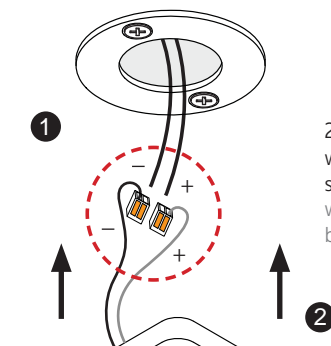

24 V DC
weiss = Plus
schwarz = Minus
white = plus
black = minus

2

3

MODUL Q 9

Leuchtenkopf / luminaire head
MODUL Q 9: 554-575 . 554-576 . 554-577

CUBIC 9

Leuchtenkopf / luminaire head
CUBIC 9: 555-795 . 555-796 . 555-797

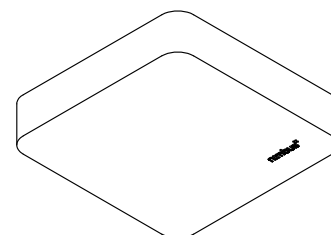
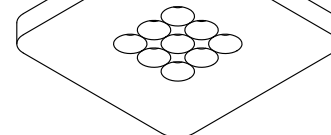

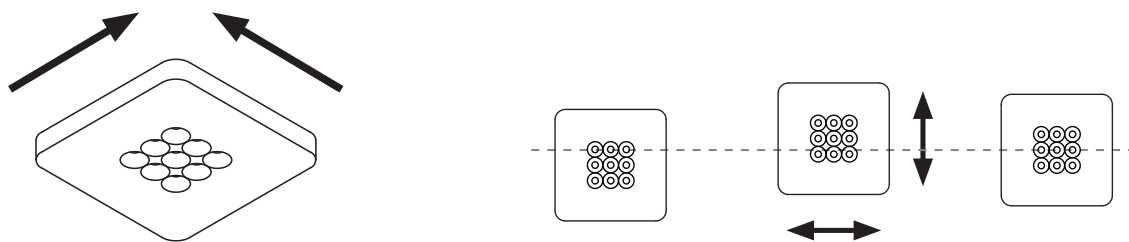

(MODUL Q 9 als Beispiel / MODUL Q 9 as an example)

4

NIMBUS Q 9 SERIE

Deckenring für **Direktmontage** / ceiling ring for **direct mounting**

ABMESSUNGEN / SIZES

002-877

