

MODUL Q 100 AQUA LED.next

DECKENLEUCTE, SPRITZWASSERGESCHÜTZT / CEILING LUMINAIRE, SPRAY WATER RESISTANT

nimbus^x

544-929 . 009-565 . 544-930

FÜR DIREKTMONTAGE (ABGEHÄNGTE DECKE)
FOR DIRECT MOUNTING (SUSPENDED CEILING)

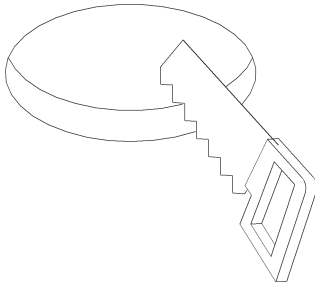
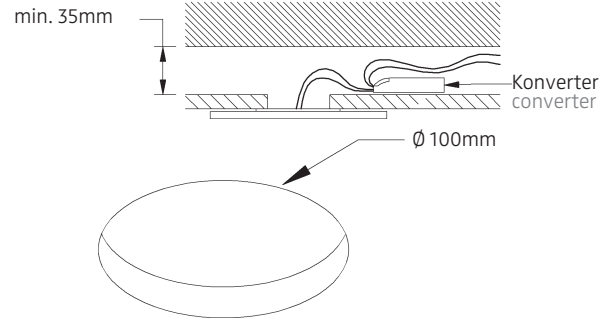

1

2

Anschluss an 230V AC
connection to 230V AC

Anschluss an 24V DC
connection to 24V DC

Anschluss an 230V AC
connection to 230V AC

Anschluss an 24V DC
connection to 24V DC

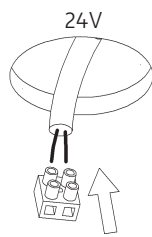
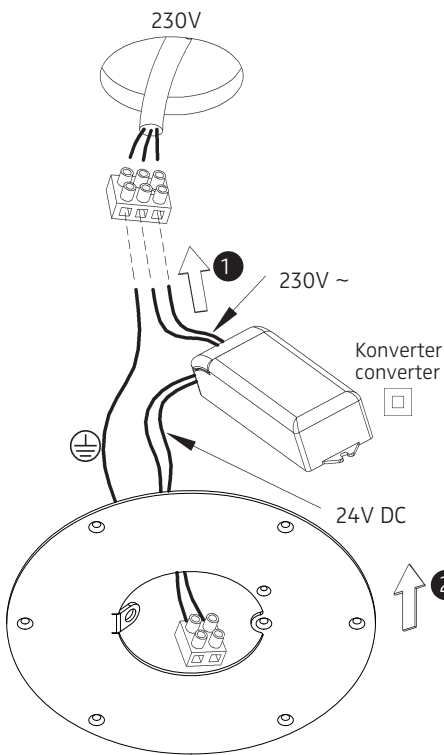

3

4

Der elektrische Anschluß darf nur vom Fachmann ausgeführt werden!
Must only be installed by a qualified electrician!

Sicherungsseil an Lasche befestigen!
Click safety rope into plate!

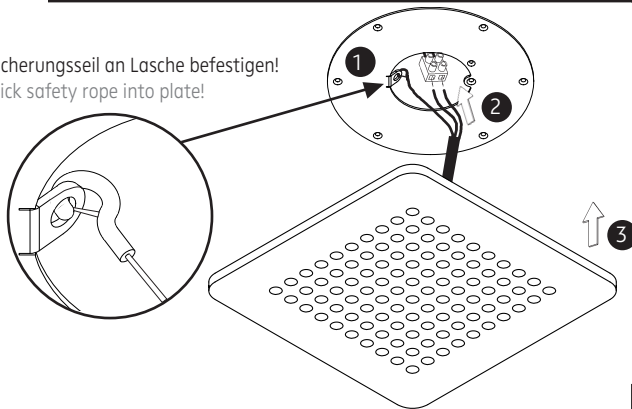

5

6

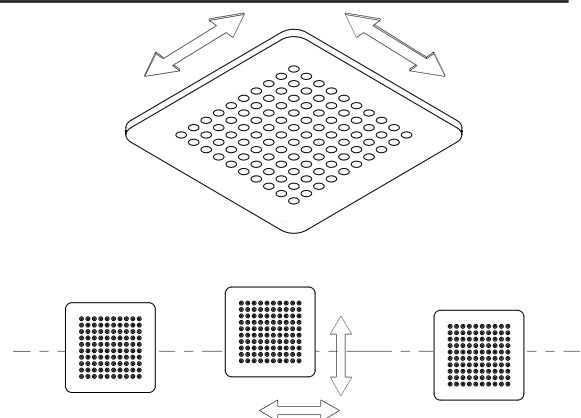

544-929 . 009-565 . 544-930

24V \equiv , Konstantspannung

24V \equiv , constant voltage

Bestückung

LEDnext 21W

lamp type

LEDnext 21W

Nimbus Group GmbH Sieglestraße 41 D-70469 Stuttgart Tel +49 - 711 - 633014-0 Fax +49 - 711 - 63301414 www.nimbus-group.com DE 03/13

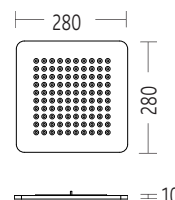

Schutzart IP 44
protection degree IP 44

MODUL Q 100 AQUA LED.next

DECKENLEUCHE, SPRITZWASSERGESCHÜTZT / CEILING LUMINAIRE, SPRAY WATER RESISTANT

544-929 . 009-565 . 544-930

nimbus^x

Deckenmontagering für Q / R 100 und 144:

