

MODUL R 49 LED.next

Deckenaufbauleuchte / surface-mounted ceiling luminaire

MONTAGE / MOUNTING

010-355 . 006-422 . 010-357

nimbus^x

Deckenauslass stromlos schalten !

Die mitgelieferten Silikonschläuche auf die Länge X kürzen und jeweils einen über eine Einzelader stülpen.

Disconnect ceiling outlet from mains !

Shorten the silicone sleeves supplied to a length of X and place one over each individual wire.

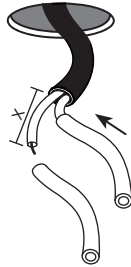

Der elektrische Anschluß darf nur vom Fachmann ausgeführt werden !
Must be installed by a qualified electrician only !

1

Geeignete Dübel und Schrauben verwenden !
Use suitable wall plugs and screws !

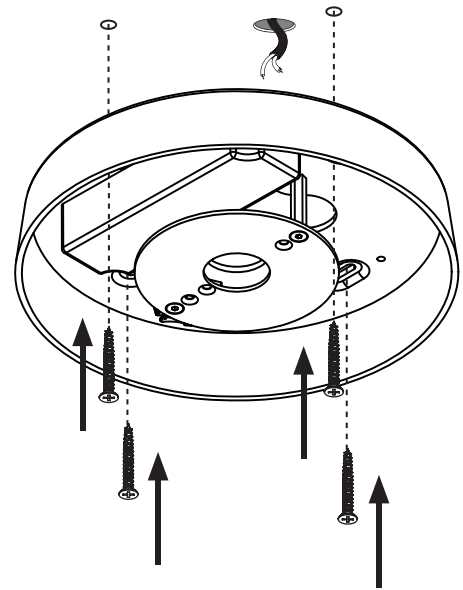

2

Anschluss an 230 V ~
connection to 230 V AC

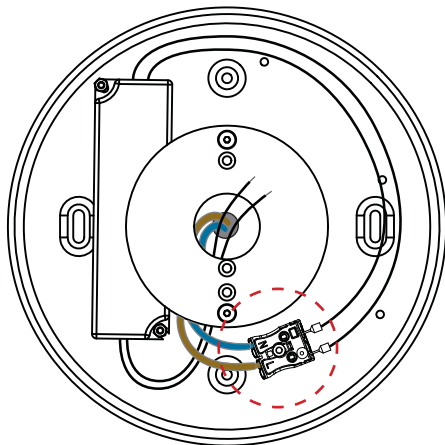
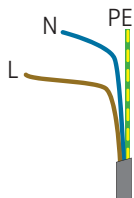

PE = grün-gelb
green-yellow
N = blau / blue
L = braun / brown

Eventuell vorhandenen Schutzleiter isolieren und im Gehäuse unterbringen !
Insulate possible PE-wire and place it inside the housing !

3

Anschluss 24 V DC
connection to 24 V DC

Klebeband an der Zuleitung entfernen !
Remove adhesive tape from supply wires !



ACHTUNG: Polarität beachten !
CAUTION: Ensure correct polarity !

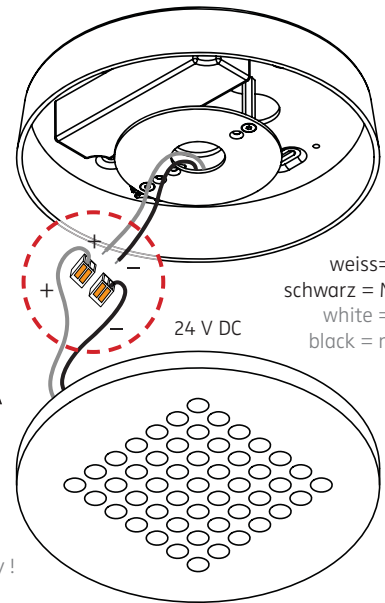

weiss = Plus
schwarz = Minus
white = plus
black = minus

4

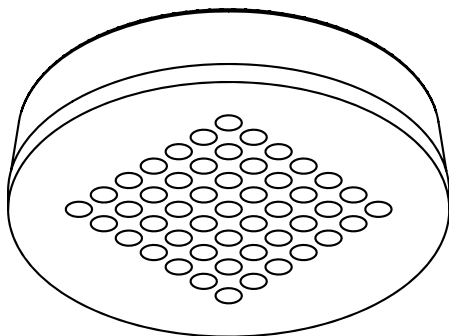

Montage und Betrieb nur in Innenräumen !
Mounting and use of luminaire only indoors !

5

010-355 . 006-422 . 010-357

230 V ~ / 50-60 Hz
230 V AC / 50-60 Hz

Bestückung: 14 W LED.next
lamp type: 14 W LED.next



Schutzart IP 20
protection degree IP 20

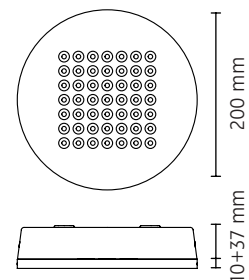

BOHRSCHABLONE / DRILLING TEMPLATE

MODUL R 49 Deckenaufbauleuchte / MODUL R 49 ceiling-mounted luminaire

010-355 | 006-422 | 010-357

ACHTUNG: Zeichnung nicht maßstäblich ! / CAUTION: Template is not drawn to scale !

