

# MODUL R 64 LED.next

Deckenaufbauleuchte / surface-mounted ceiling luminaire

## MONTAGE / MOUNTING

010-375 . 006-425 . 010-377

nimbus<sup>x</sup>

### Deckenauslass stromlos schalten !

Die mitgelieferten Silikonschläuche auf die Länge X kürzen und jeweils einen über eine Einzelader stülpen.

### Disconnect ceiling outlet from mains !

Shorten the silicone sleeves supplied to a length of X and place one over each individual wire.

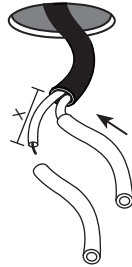

Der elektrische Anschluß darf nur vom Fachmann ausgeführt werden !  
Must be installed by a qualified electrician only !

1

2

Geeignete Dübel und Schrauben verwenden !

Use suitable wall plugs and screws !

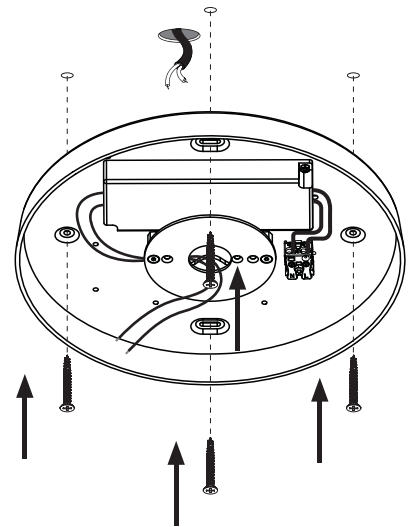

Anschluss an 230 V ~  
connection to 230 V AC

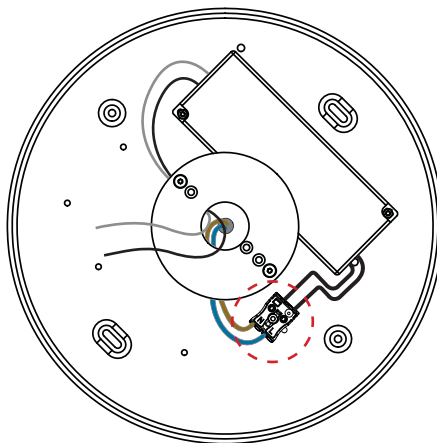
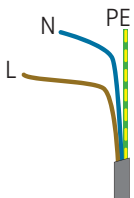

PE = grün-gelb  
green-yellow  
N = blau / blue  
L = braun / brown

Eventuell vorhandenen Schutzleiter isolieren und im Gehäuse unterbringen !  
Insulate possible PE-wire and place it inside the housing !

3

Anschluss 24 V DC  
connection to 24 V DC

Klebeband an der Zuleitung entfernen !  
Remove adhesive tape from supply wires !



ACHTUNG: Polarität beachten !  
CAUTION: Ensure correct polarity !

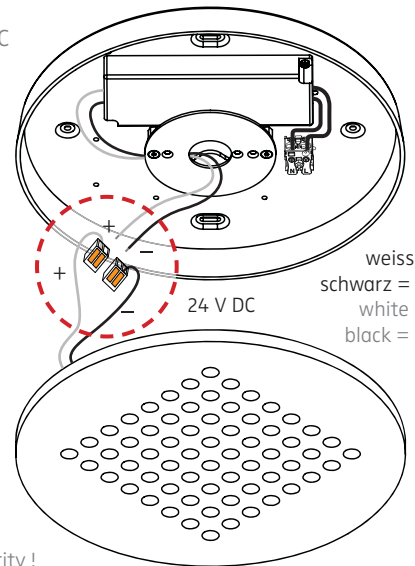

weiss = Plus  
schwarz = Minus  
white = plus  
black = minus

4

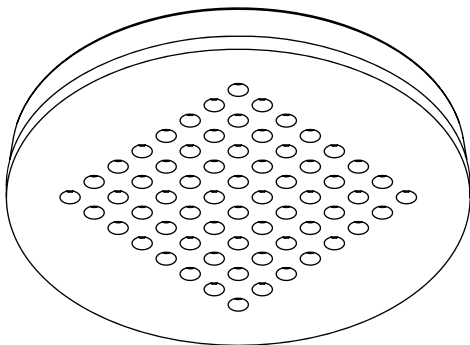

Montage und Betrieb nur in Innenräumen !  
Mounting and use of luminaire only indoors !

5

010-375 . 006-425 . 010-377

230 V ~ / 50-60 Hz  
230 V AC / 50-60 Hz

Bestückung: 16 W LED.next  
lamp type: 16 W LED.next



Schutzart IP 20  
protection degree IP 20

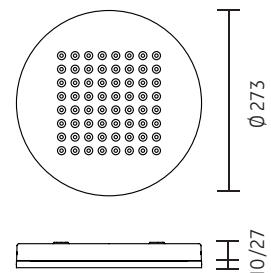

## BOHRSCHABLONE / DRILLING TEMPLATE

MODUL R 64 - Deckenaufbauleuchte / surface-mounted ceiling luminaire

010-375 | 006-425 | 010-377

ACHTUNG: Zeichnung nicht maßstäblich ! / CAUTION: Template is not drawn to scale !

