

# MODUL R 9 LED.next

DECKENLEUCHE SPRITZWASSERGESCHÜTZT;  
CEILING-MOUNTED LUMINAIRE SPRAY WATER RESISTANT

nimbus<sup>x</sup>

007-407 . 010-402 . 010-404

FÜR HOHLRAUMEINBAU (ABGEHÄNGTE DECKE) / HALOX-O  
FOR PLASTERBOARD (SUSPENDED CEILING) / HALOX-O

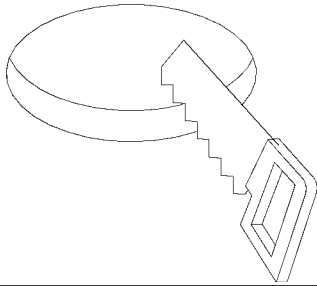

1

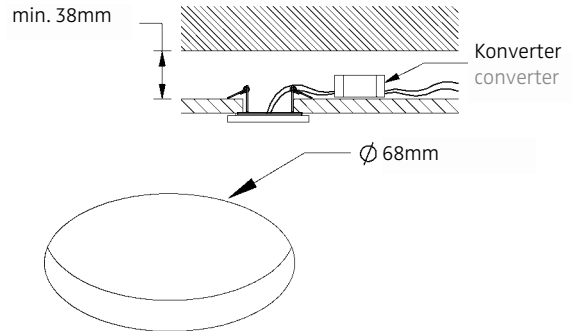

2

Anschluss mit 230V AC  
connection with 230V AC

Anschluss mit 24V DC  
connection with 24V DC

230V

24V

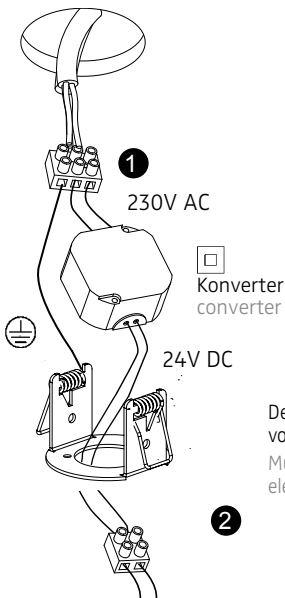

2

Der elektrische Anschluß darf nur vom Fachmann ausgeführt werden!  
Must only be installed by a qualified electrician!



Anschluss mit 230V AC  
connection with 230V AC

Anschluss mit 24V DC  
connection with 24V DC

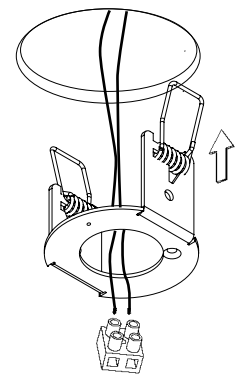
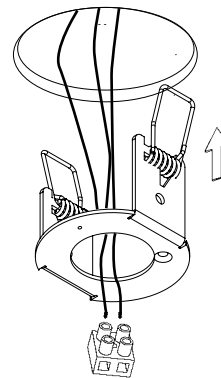

3

4

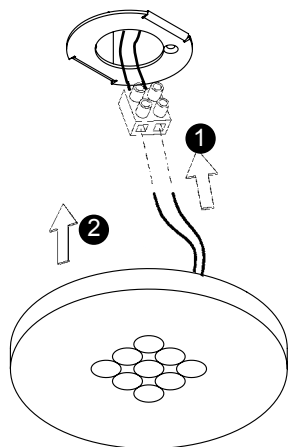

5

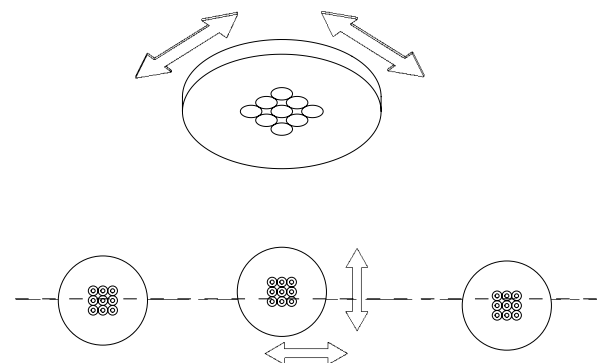

6

007-407 . 010-402 . 010-404

24V DC, Konstantspannung  
24V DC, constant voltage

Bestückung  
LEDnext 3W  
lamp type  
LEDnext 3W

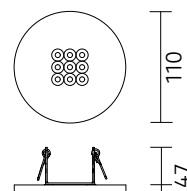

Schutzart IP 44  
protection degree IP 44