

MODUL R 220 PROJECT IQ-SENSOR

Deckenleuchte für Direktmontage mit IQ-Steuerung und PDLs
ceiling luminaire for direct mounting with IQ control and PDLs

nimbus^x

MONTAGE / MOUNTING

554-884 . 554-883 . 554-885



Montage und Betrieb nur in Innenräumen!
Mounting and use of luminaire only indoors!

- A** Direktmontage in abgehängter Decke
direct mounting in a suspended ceiling

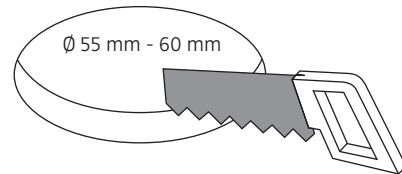
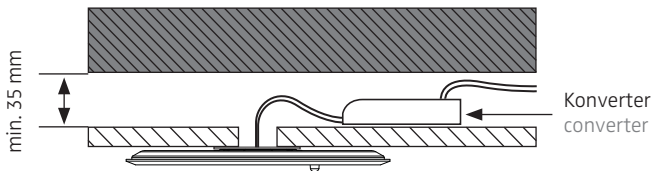

- B** für Hohlraumeinbau in poröse Materialien mit geeigneter Hohlraumdose
for installation in porous materials with suitable ceiling junction box

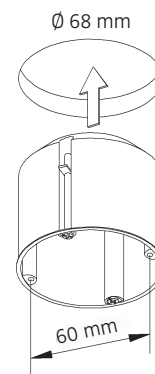
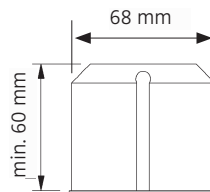
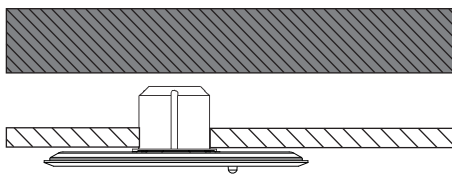

- C** für Unterputz / Mauerwerk mit geeigneter Decken-Verbindungsdose
for brick / hollow blocks with suitable ceiling junction box

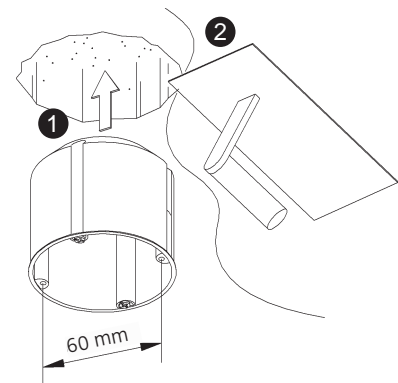
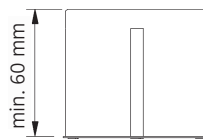
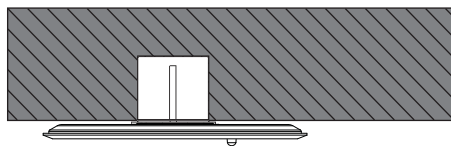

- D** Montage in Decken-Verbindungsdose für Beton (z.B. Spelsberg U71)
installation in ceiling junction box for concrete (e.g. Spelsberg U71)

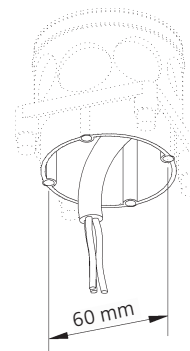
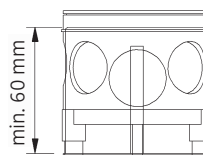
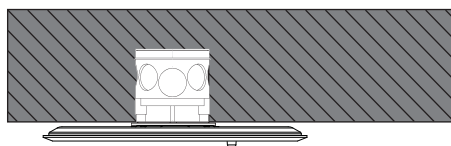

554-884 . 554-883 . 554-885

nimbus^x

Anschluss an 230 V ~
connection to 230 V AC

Eventuell vorhandenen Schutzleiter isolieren und in der abgehängten Decke unterbringen !
Insulate possible PE-wire and place it inside of the suspended ceiling !

Konverter je nach Baugröße in Deckendose oder abgehängter Decke platzieren.
Depending on its size place converter inside of the ceiling box or in the suspended ceiling.

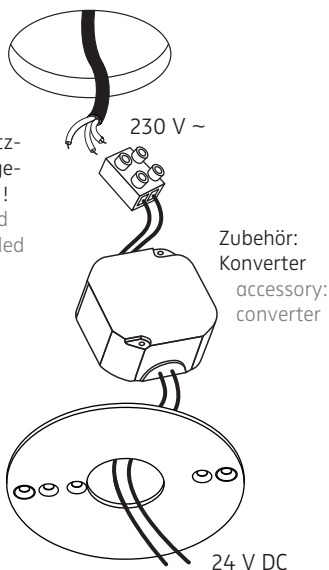

Anschluss an 24 V DC
connection to 24 V DC

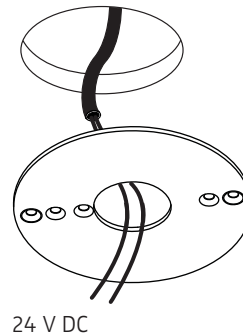

Der elektrische Anschluss darf nur vom Fachmann ausgeführt werden !
Must be installed by a qualified electrician only !

1

Senkkopfschrauben müssen plan mit dem Deckenring abschließen !
The countersunk bolts must be on one level with the mounting ring !

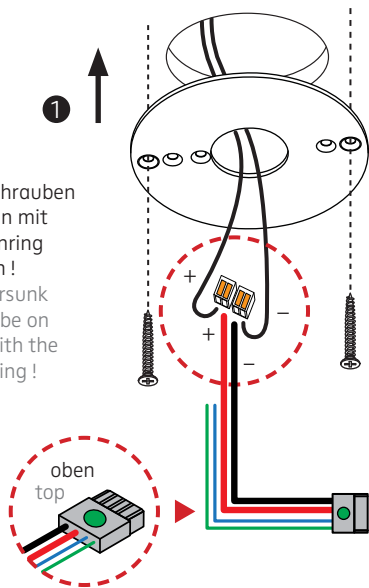

ACHTUNG: Polarität beachten !
CAUTION: Ensure correct polarity !

2
24 V DC
rot = Plus
schwarz = Minus
red = plus
black = minus
grün, blau = nicht belegt
green, blue = not assigned

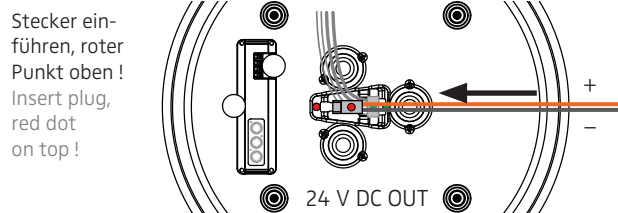
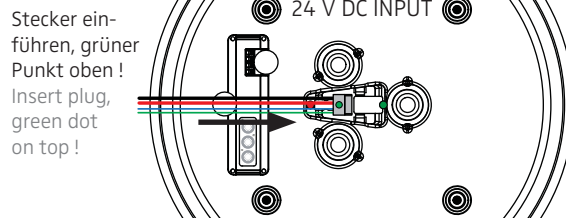

ACHTUNG: Leuchte NICHT an der Zuleitung hängen lassen. Zum Lösen der 24 V-Steckverbindung NUR horizontal in Richtung des Kabels ziehen !
CAUTION: Do NOT suspend luminaire from this supply cord. To detach the 24 V connection ONLY pull horizontally in the direction of the cable !

2

3

ACHTUNG:

Die 24 V-Weiterleitung gibt das gedimmte oder geschaltete Signal an nachfolgende Leuchten weiter. Somit lassen sich im Rahmen der verfügbaren Konverterleistung Dimmgruppen bilden. Die zulässige Gesamtbelastbarkeit eines solchen Systems inklusive Masterleuchte liegt bei 120 W / 5 A !

HINWEIS: Ungenutzte Adern unbedingt isolieren !

CAUTION:

The 24 V forwarding delivers the dimmed or switched signal to following luminaires. So it is possible to create dimming groups within the available converter power.

The permitted power handling of such a system amounts up to 120 W / 5 A including the master luminaire !

NOTE: Unused wires must be isolated !

IQ-STEUERUNG
IQ CONTROL

INFO:



Folgende Funktions-Parameter können direkt am Steuerriegel eingestellt werden:

The following functions can directly be adjusted by means of the set screws of the control bar:

F1: Helligkeitswert / brightness level

F2: Leuchtdauer / light „ON“ time

F3: Grundhelligkeit / basic brightness

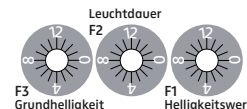

4

5

nimbus^x

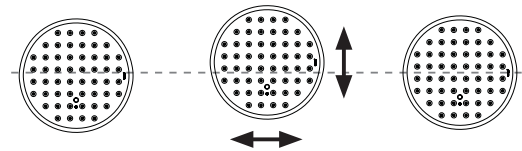
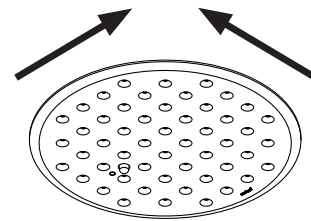
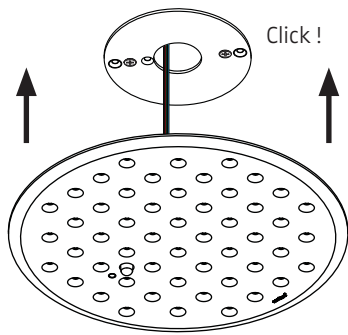

6

7

554-884 . 554-883 . 554-885

24 V DC Konstantspannung
24 V DC constant voltage

Leistungsdaten siehe Typenschild!
Performance data see rating label!

Schutzart IP 20
protection degree IP 20

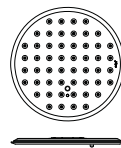

H 280
H 17



Am Ende seiner Lebensdauer darf dieses Produkt nicht mit dem Hausmüll entsorgt werden. Bringen Sie es bitte zu einer kommunalen Sammelstelle für elektrische und elektronische Altgeräte.

Leuchtmittel kann nicht gewechselt werden!
The luminaire contains no replaceable light source!



This product must not be disposed of with the household refuse at the end of its life cycle. Take it to your local disposal centre for electrical and electronic waste.

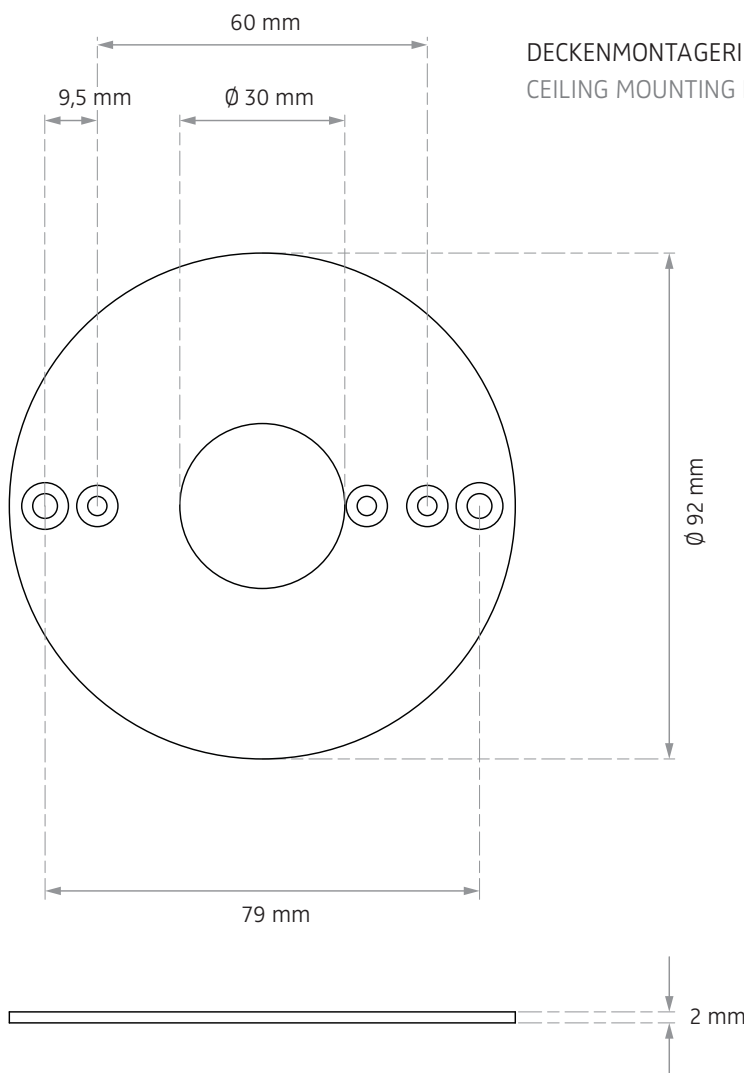

DECKENMONTAGERING FÜR MODUL R PROJECT 220 / 280 / 340
CEILING MOUNTING RING FOR MODUL R PROJECT 220 / 280 / 340