

MODUL R 280 PROJECT IQ-SENSOR

Deckenaufbauleuchte für Direktmontage mit IQ-Steuerung und PDLS
surface-mounted ceiling luminaire for direct mounting with IQ control and PDLS

nimbus^x

MONTAGE / MOUNTING

554-983 . 554-982 . 554-984



Montage und Betrieb nur in Innenräumen!
Mounting and use of luminaire only indoors!

- A** Direktmontage in abgehängter Decke
direct mounting in a suspended ceiling

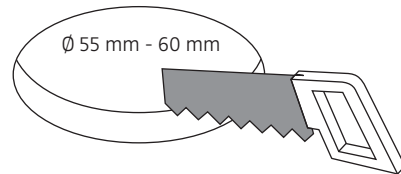
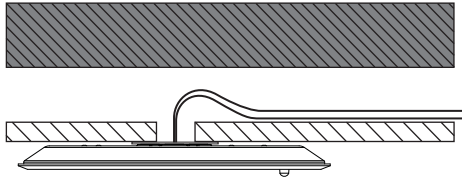

- B** für Hohlraumeinbau in poröse Materialien mit geeigneter Hohlraumdose
for installation in porous materials with suitable ceiling junction box

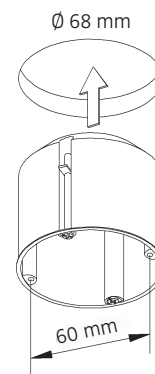
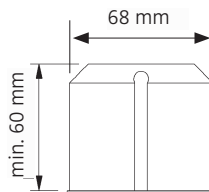
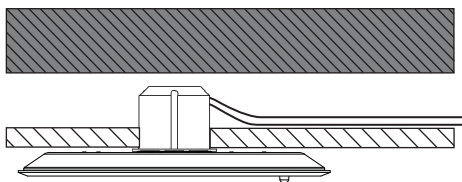

- C** für Unterputz / Mauerwerk mit geeigneter Decken-Verbindungsdose
for brick / hollow blocks with suitable ceiling junction box

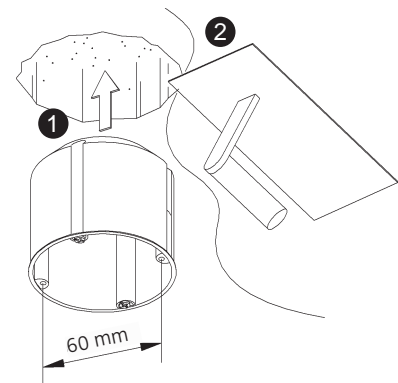
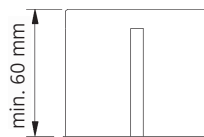
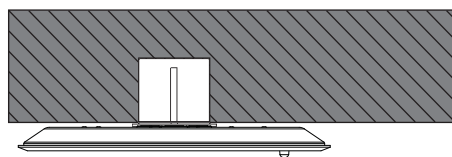

- D** Montage in Decken-Verbindungsdose für Beton (z.B. Spelsberg U71)
installation in ceiling junction box for concrete (e.g. Spelsberg U71)

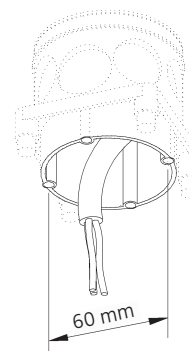
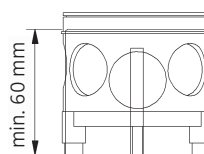
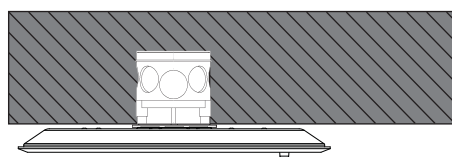

Anschluss an 230 V ~
connection to 230 V AC

Deckenauslass stromlos schalten !

Die mitgelieferten Silikonschläuche auf die Länge X kürzen und jeweils einen über die Einzeladern N und L schieben. Dadurch wird eine Verdrängung gemäß Schutzklasse II sichergestellt.

Disconnect ceiling outlet from mains !

Shorten the silicone sleeves supplied to a length of X and place one over the individual wires marked N and L. This ensures protection class II.

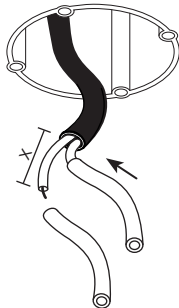

Senkkopfschrauben müssen plan mit dem Deckenring abschließen !

The countersunk bolts must be on a level with the mounting ring !

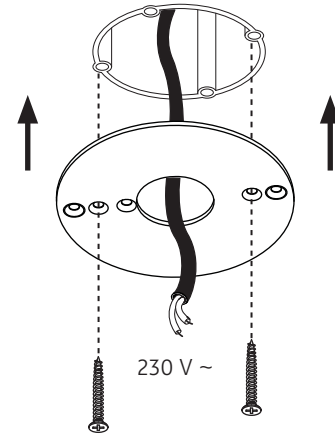

Der elektrische Anschluss darf nur vom Fachmann ausgeführt werden !
Must be installed by a qualified electrician only !

1

2

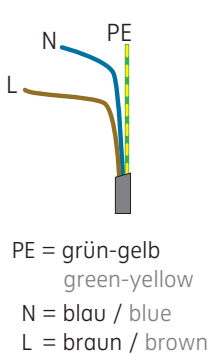

PE = grün-gelb
green-yellow
N = blau / blue
L = braun / brown

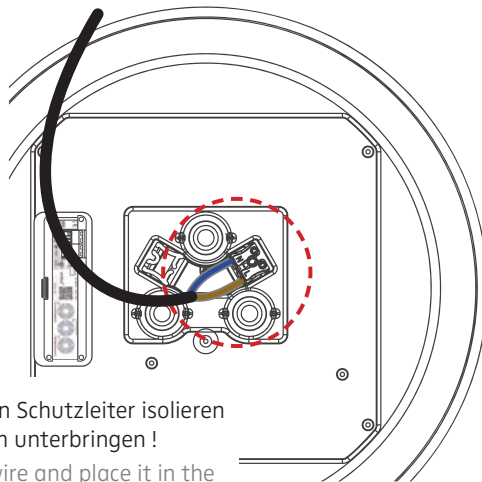

Eventuell vorhandenen Schutzleiter isolieren und im Anschlussraum unterbringen !
Insulate possible PE-wire and place it in the connection area on top of the luminaire !

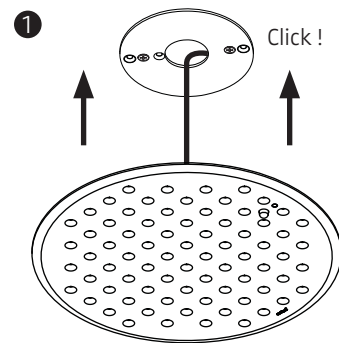

Folgende Funktions-Parameter können direkt am Steuerriegel eingestellt werden:

The following functions can directly be adjusted by means of the set screws of the control bar:

F1: Helligkeitswert / brightness level
F2: Leuchtdauer / light „ON“ time
F3: Grundhelligkeit / basic brightness

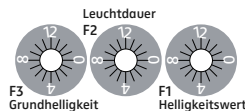

2

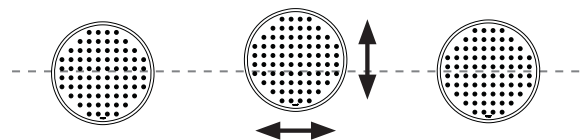

3

4

554-983 . 554-982 . 554-984

230 V ~ (50 Hz) / 230 V AC / (50 Hz)

Leistungsdaten siehe Typenschild !
Performance data see rating label !

Schutzart IP 20
protection degree IP 20

INFO:

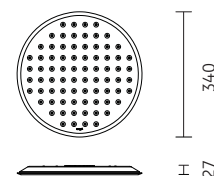

Schutzklasse II / doppelte Isolierung
protection class II / double insulation



Leuchtmittel kann nicht gewechselt werden !
The luminaire contains no replaceable light source !

Am Ende seiner Lebensdauer darf dieses Produkt nicht mit dem Hausmüll entsorgt werden. Bringen Sie es bitte zu einer kommunalen Sammelstelle für elektrische und elektronische Altgeräte. This product must not be disposed of with the household refuse at the end of its life cycle. Take it to your local disposal centre for electrical and electronic waste.

MODUL R 280 PROJECT IQ-SENSOR

Deckenaufbauleuchte für Direktmontage mit IQ-Steuerung und PDLs
surface-mounted ceiling luminaire for direct mounting with IQ control and PDLs

554-983 . 554-982 . 554-984

nimbus^x

DECKENMONTAGERING FÜR MODUL R PROJECT 220 / 280 / 340

CEILING MOUNTING RING FOR MODUL R PROJECT 220 / 280 / 340

