

MODUL Q 280 PROJECT

Deckenaufbauleuchte für Direktmontage, dimmbar DALI/switchDim
surface mounted ceiling luminaire for direct mounting, dimmable DALI/switchDim

nimbus^x

MONTAGE / MOUNTING

550-187 . 550-186 . 550-188



Montage und Betrieb nur in Innenräumen!
Mounting and use of luminaire only indoors!

- A** Direktmontage in abgehängter Decke
direct mounting in a suspended ceiling

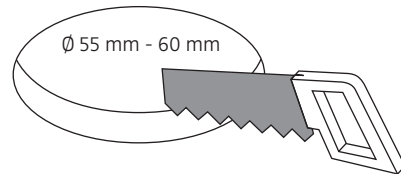
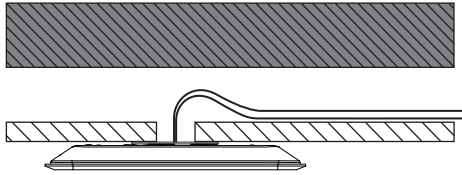

- B** für Hohlraumeinbau in poröse Materialien mit geeigneter Hohlraumdose
for installation in porous materials with suitable ceiling junction box

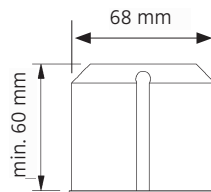
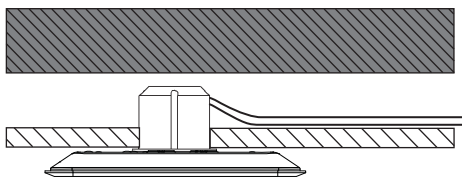

- C** für Unterputz / Mauerwerk mit geeigneter Decken-Verbindungsdose
for brick / hollow blocks with suitable ceiling junction box

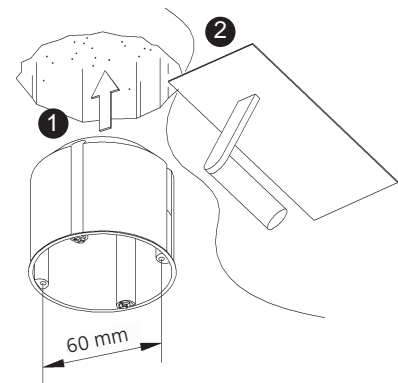
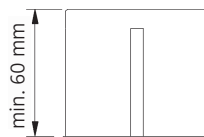
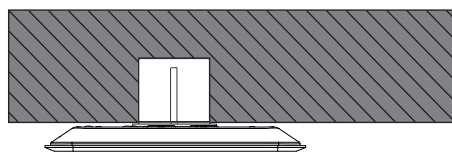

- D** Montage in Decken-Verbindungsdose für Beton (z.B. Spelsberg U71)
installation in ceiling junction box for concrete (e.g. Spelsberg U71)

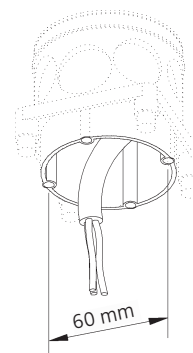
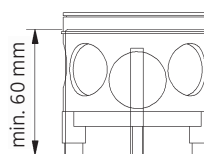
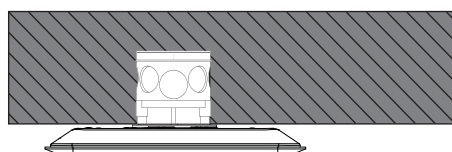

Anschluss an 230 V ~ / connection to 230 V AC

Deckenauslass stromlos schalten !

Die mitgelieferten Silikonschläuche auf die Länge X kürzen und jeweils einen über die Einzeladern N und L (optional auch über die Steuerleitungen vom Taster) schieben. Dadurch wird eine Verdrahtung gemäß Schutzklasse II sichergestellt. Eventuell vorhandenen Schutzleiter (PE) isolieren und im Anschlussraum unterbringen.

Disconnect ceiling outlet from mains !

Shorten the silicone sleeves supplied to a length of X and place one over the individual wires marked N and L (over optional control wires from push button as well). This ensures protection class II. Insulate possible PE-wire and place it in the connection area on top of the luminaire.

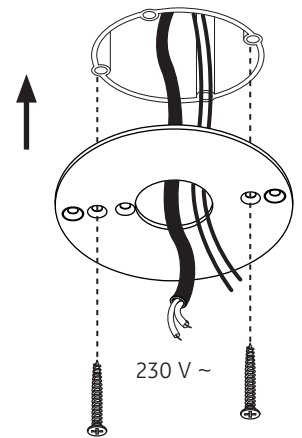
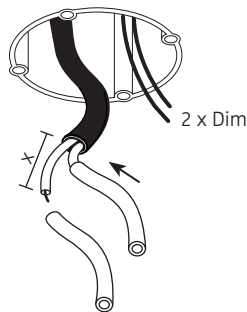

Senkkopfschrauben müssen plan mit dem Deckenring abschließen !
The countersunk bolts must be on a level with the mounting ring !

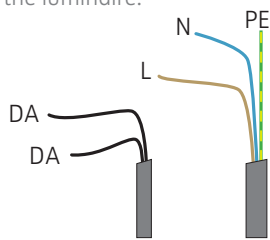

grün-gelb / green-yellow : PE
blau / blue : N
braun / brown : L
2 x schwarz : DALI Dimmung
2 x black : DALI control wires



Der elektrische Anschluss darf nur vom Fachmann ausgeführt werden !
Must be installed by a qualified electrician only !

1 2

Anschluss an 230 V ~ und DALI-Signal / Taster-Signal
connection to 230 V AC and DALI signal / push button signal

PE = grün-gelb
green-yellow
N = blau / blue
L = braun / brown

2 x schwarz = DALI-Signal
2 x black = DALI signal

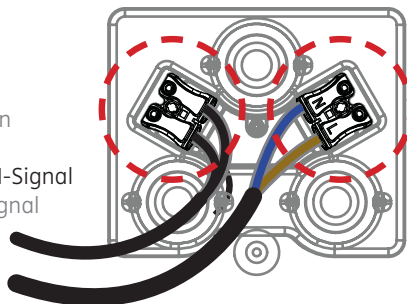

Phase vom Netzspannungstaster
live wire from push button (mains)
Brücke Null-Leiter (N)
bridged neutral (N)

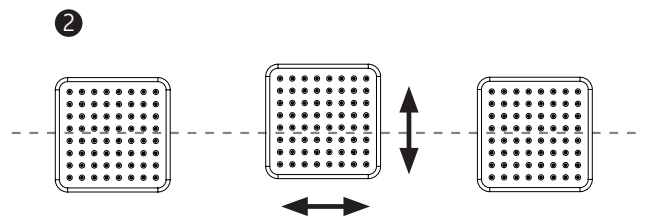
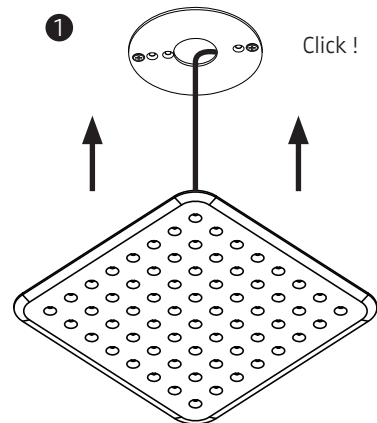
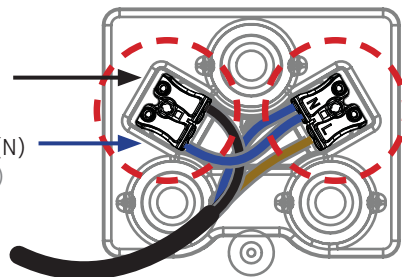

3 4

550-187 . 550-186 . 550-188

230 V ~ (50 Hz) / 230 V AC / (50 Hz)

Leistungsdaten siehe Typenschild !
Performance data see rating label !

Schutzart IP 20
protection degree IP 20

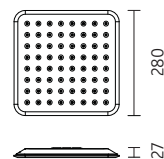

Schutzklasse II / doppelte Isolierung
protection class II / double insulation



Leuchtmittel kann nicht gewechselt werden !
The luminaire contains no replaceable light source !

Am Ende seiner Lebensdauer darf dieses Produkt nicht mit dem Hausmüll entsorgt werden. Bringen es bitte zu einer kommunalen Sammelstelle für elektrische und elektronische Altgeräte.
This product must not be disposed of with the household refuse at the end of its life cycle. Take it to your local disposal centre for electrical and electronic waste.

MODUL Q 280 PROJECT

Deckenaufbauleuchte für Direktmontage
surface-mounted ceiling luminaire for direct mounting

nimbus^x

550-187 . 550-186 . 550-188

DECKENMONTAGERING FÜR MODUL Q 220 / 280 / 340 PROJECT
CEILING MOUNTING RING FOR MODUL Q 220 / 280 / 340 PROJECT

