

# MODUL R 280 PROJECT

Deckenaufbauleuchte für Direktmontage, dimmbar DALI/switchDim  
surface mounted ceiling luminaire for direct mounting, dimmable DALI/switchDim

# nimbus<sup>x</sup>

## MONTAGE / MOUNTING

552-960 . 552-959 . 552-961



Montage und Betrieb nur in Innenräumen!  
Mounting and use of luminaire only indoors!

- A** Direktmontage in abgehängter Decke  
direct mounting in a suspended ceiling

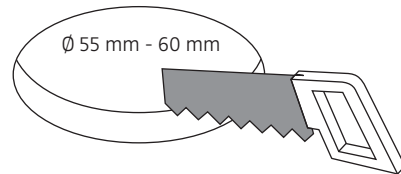
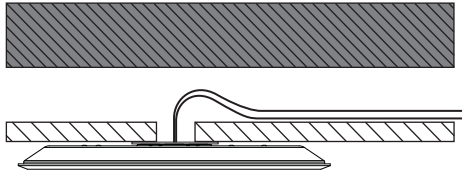

- B** für Hohlraumeinbau in poröse Materialien mit geeigneter Hohlraumdose  
for installation in porous materials with suitable ceiling junction box

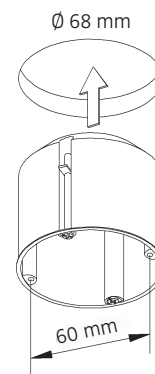
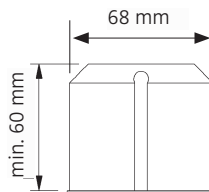
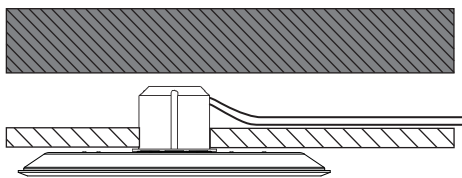

- C** für Unterputz / Mauerwerk mit geeigneter Decken-Verbindungsdose  
for brick / hollow blocks with suitable ceiling junction box

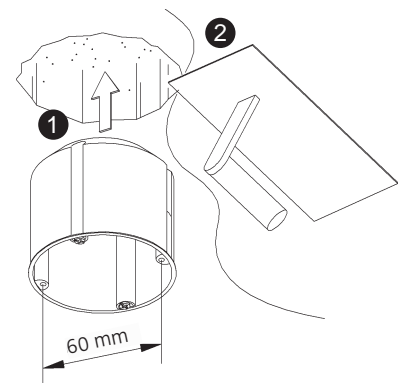
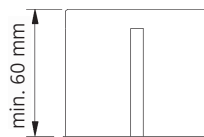
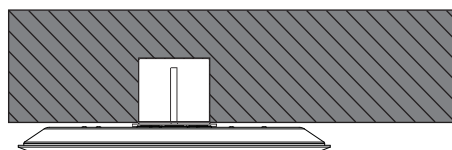

- D** Montage in Decken-Verbindungsdose für Beton (z.B. Spelsberg U71)  
installation in ceiling junction box for concrete (e.g. Spelsberg U71)

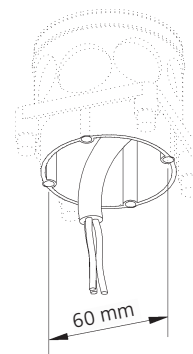
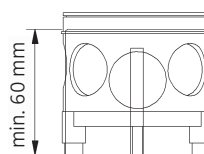
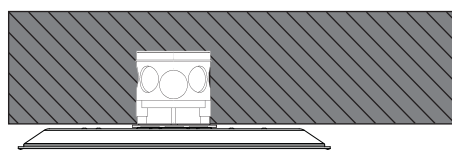

Anschluss an 230 V ~  
connection to 230 V AC

**Deckenauslass stromlos schalten !**

Die mitgelieferten Silikonschläuche auf die Länge X kürzen und jeweils einen über die Einzeladern N und L (optional auch über Steuerleitungen vom Taster) schieben. Eventuell vorhandenen Schutzleiter (PE) isolieren und im Anschlussraum unterbringen.

**Disconnect ceiling outlet from mains !**

Shorten the silicone sleeves supplied to a length of X and place one over the individual wires marked N and L (over optional control wires from push button as well).

Insulate possible PE-wire and place it in the connection area on top of the luminaire.

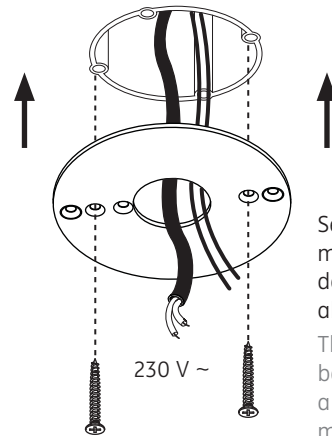
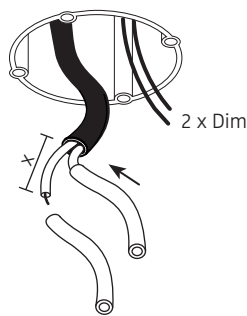

Senkkopfschrauben müssen plan mit dem Deckenring abschließen !

The countersunk bolts must be on a level with the mounting ring !

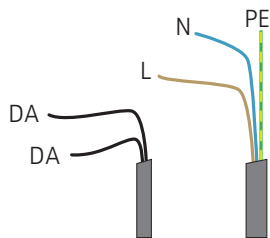

grün-gelb / green-yellow : PE  
blau / blue : N  
braun / brown : L  
2 x schwarz : DALI Dimmung  
2 x black : DALI control wires



Der elektrische Anschluss darf nur vom Fachmann ausgeführt werden !  
Must be installed by a qualified electrician only !

1

2

Anschluss an 230 V ~ und DALI-Signal / Taster-Signal  
connection to 230 V AC and DALI signal / push button signal

PE = grün-gelb  
green-yellow  
N = blau / blue  
L = braun / brown

2 x schwarz = DALI-Signal  
2 x black = DALI signal

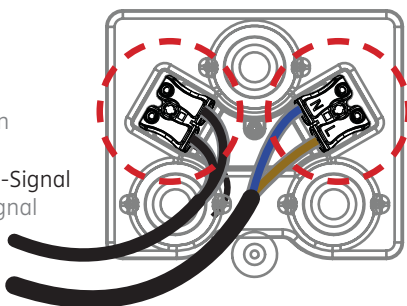

Phase vom Netzspannungstaster  
live wire from push button (mains)  
Brücke Null-Leiter (N)  
bridged neutral (N)

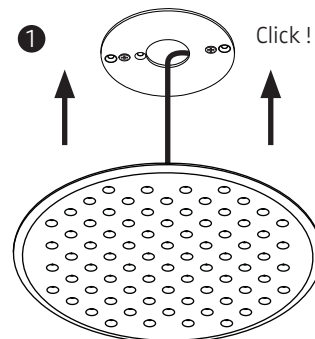
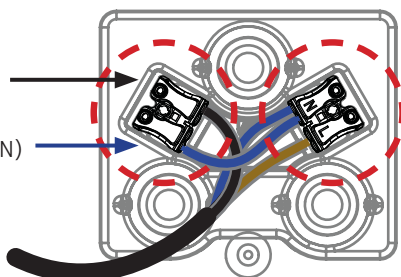

2

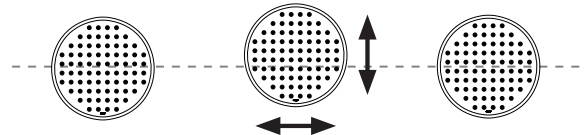

3

4

552-960 . 552-959 . 552-961

230 V ~ (50 Hz) / 230 V AC / (50 Hz)

Leistungsdaten siehe Typenschild !  
Performance data see rating label !



Schutzart IP 20  
protection degree IP 20

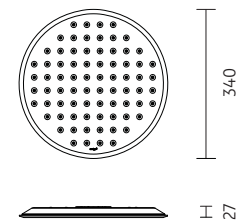

# MODUL R 280 PROJECT

Deckenaufbauleuchte für Direktmontage  
surface-mounted ceiling luminaire for direct mounting

552-960 . 552-959 . 552-961

nimbus<sup>x</sup>

DECKENMONTAGERING FÜR MODUL R 220 / 280 / 340 PROJECT  
CEILING MOUNTING RING FOR MODUL R 220 / 280 / 340 PROJECT

