

# MODUL R 340 PROJECT

Deckenleuchte für Direktmontage / ceiling luminaire for direct mounting

# nimbus<sup>x</sup>

## MONTAGE / MOUNTING

551-217 . 550-356 . 551-218



Montage und Betrieb nur in Innenräumen!  
Mounting and use of luminaire only indoors!

- (A)** Direktmontage in abgehängter Decke  
direct mounting in a suspended ceiling

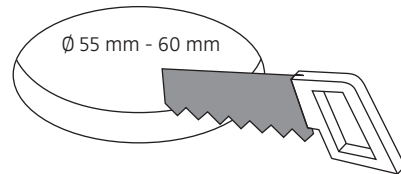
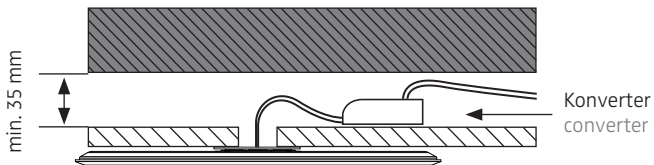

- (B)** für Hohlraumeinbau in poröse Materialien mit geeigneter Hohlraumdose  
for installation in porous materials with suitable ceiling junction box

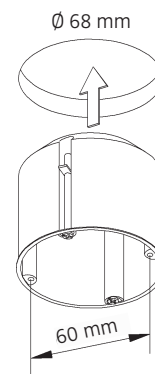
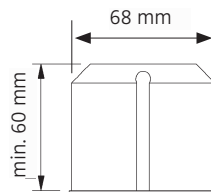
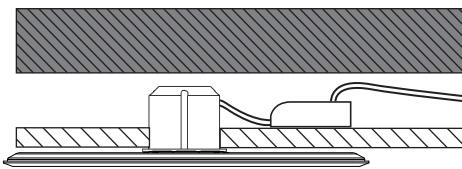

- (C)** für Unterputz / Mauerwerk mit geeigneter Decken-Verbindungsdose  
for brick / hollow blocks with suitable ceiling junction box

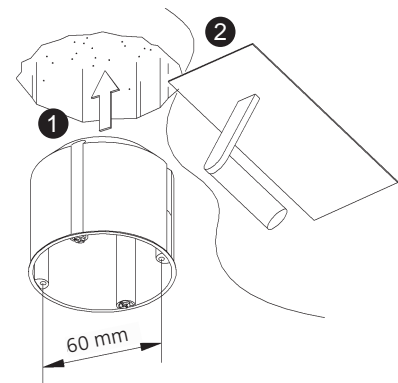
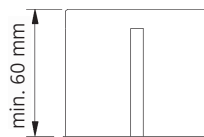
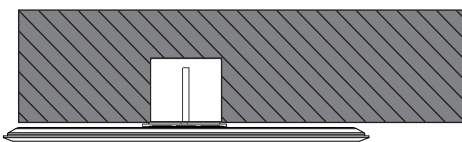

- (D)** Montage in Decken-Verbindungsdose für Beton (z.B. Spelsberg U71)  
installation in ceiling junction box for concrete (e.g. Spelsberg U71)

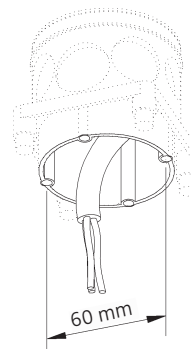
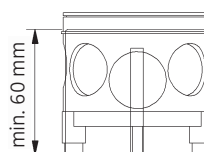
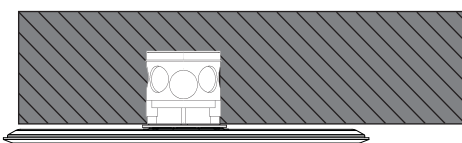

551-217 . 550-356 . 551-218

nimbus<sup>x</sup>

Anschluss an 230 V ~  
connection to 230 V AC

Eventuell vorhandenen Schutzleiter isolieren und in der abgehängten Decke unterbringen!  
Insulate possible PE-wire and place it inside of the suspended ceiling!

Konverter je nach Baugröße in Deckendose oder abgehängter Decke platzieren.  
Depending on its size place converter inside of the ceiling box or in the suspended ceiling.

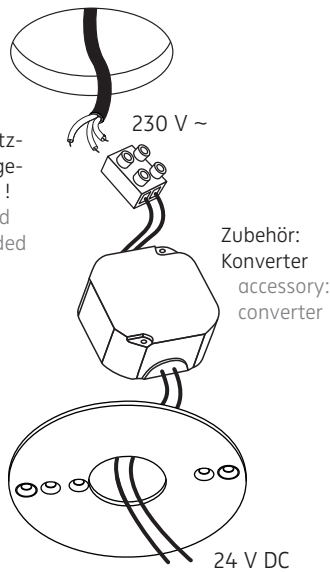

Anschluss an 24 V DC  
connection to 24 V DC

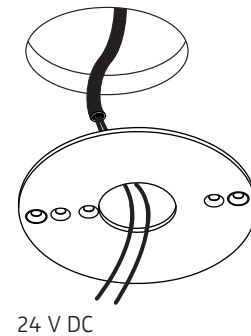

Der elektrische Anschluss darf nur vom Fachmann ausgeführt werden!  
Must be installed by a qualified electrician only!

1

Senkkopfschrauben müssen plan mit dem Deckenring abschließen!  
The countersunk bolts must be on one level with the mounting ring!

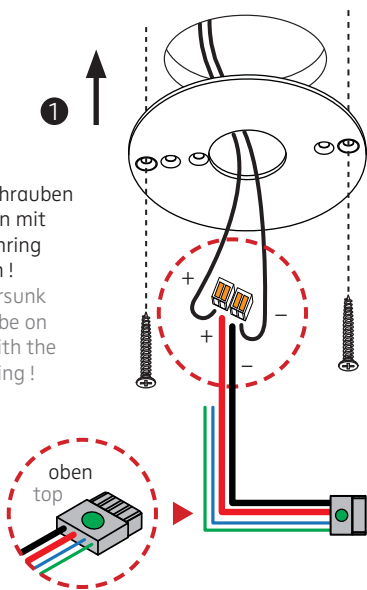

ACHTUNG: Polarität beachten!  
CAUTION: Ensure correct polarity!

Stecker einführen, grüner Punkt oben!  
Insert plug, green dot on top!

2  
24 V DC  
rot = Plus  
schwarz = Minus  
red = plus  
black = minus  
grün, blau = nicht belegt  
green, blue = not assigned



ACHTUNG: Leuchte NICHT an der Zuleitung hängen lassen. Zum Lösen der 24 V-Steckverbindung NUR horizontal in Richtung des Kabels ziehen!

CAUTION: Do NOT suspend luminaire from this supply cord. To detach the 24 V connection ONLY pull horizontally in the direction of the cable!

2

3

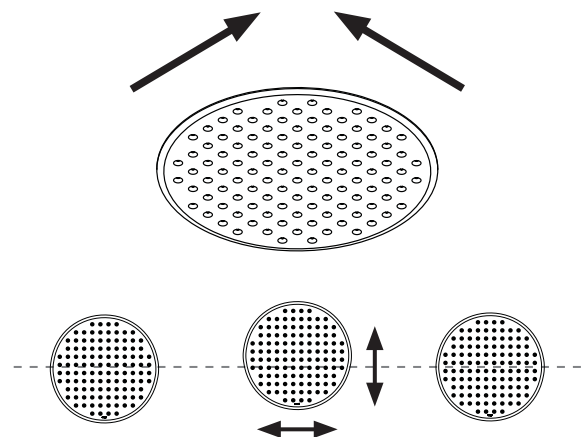
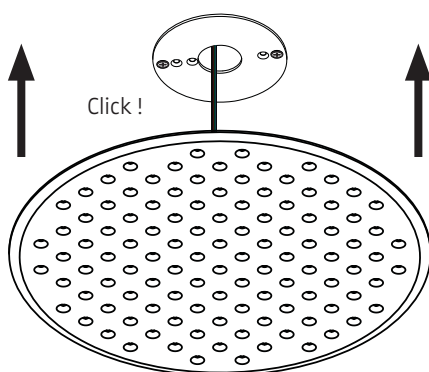

4

5

# MODUL R 340 PROJECT

Deckenleuchte für Direktmontage / ceiling luminaire for direct mounting

nimbus<sup>x</sup>

551-217 . 550-356 . 551-218

24 V DC Konstanzspannung  
24 V DC constant voltage

Leistungsdaten siehe Typenschild!  
Performance data see rating label!

Schutzart IP 20  
protection degree IP 20

Leuchtmittel kann nicht gewechselt werden!  
The luminaire contains no replaceable light source!

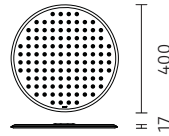

Am Ende seiner Lebensdauer darf dieses Produkt nicht mit dem Hausmüll entsorgt werden. Bringen Sie es bitte zu einer kommunalen Sammelstelle für elektrische und elektronische Altgeräte.

This product must not be disposed of with the household refuse at the end of its life cycle. Take it to your local disposal centre for electrical and electronic waste.

## DECKENMONTAGERING FÜR MODUL R PROJECT 220 / 280 / 340

CEILING MOUNTING RING FOR MODUL R PROJECT 220 / 280 / 340

