

# MANUAL

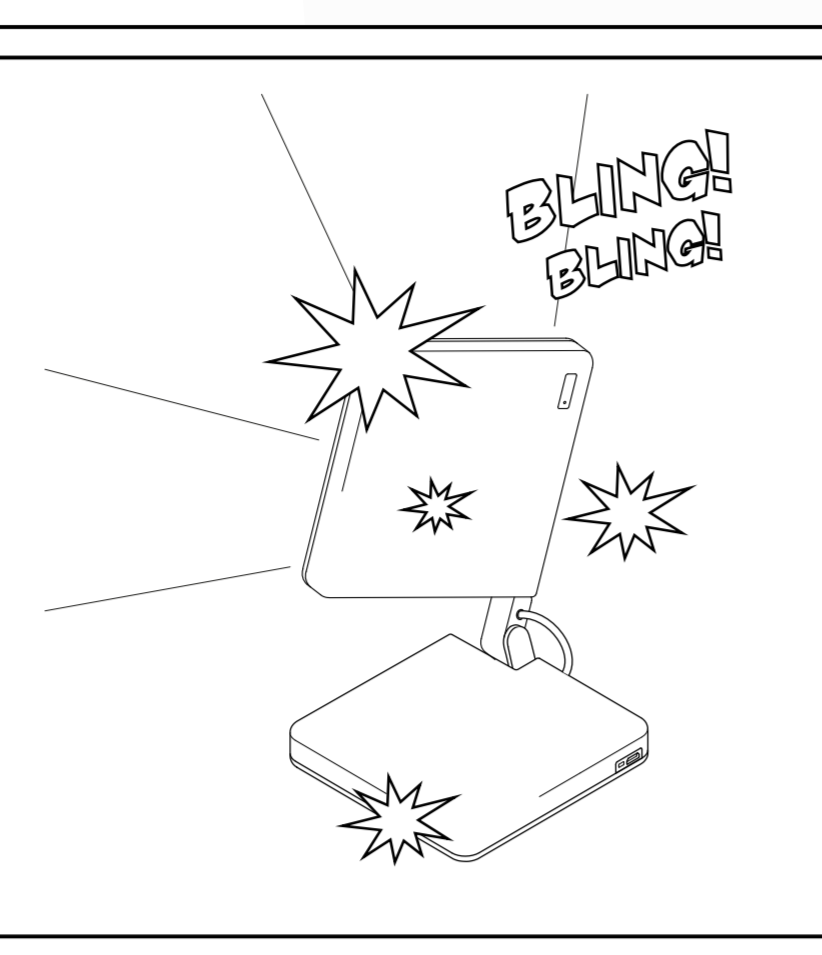

## READY TO PLAY

DIE LEUCHE WIRD WERKSSEITIG MIT ETWA 40-60% AKKULADUNG AUSGELIEFERT UND KANN NACH DEM AUSPACKEN SOFORT BENUTZT WERDEN. THE LUMINAIRE IS DELIVERED WITH A CELL CHARGED WITH APPROX. 40-60% CAPACITY AND IS IMMEDIATELY READY TO GO AFTER UNBOXING.



## LOCK/UNLOCK

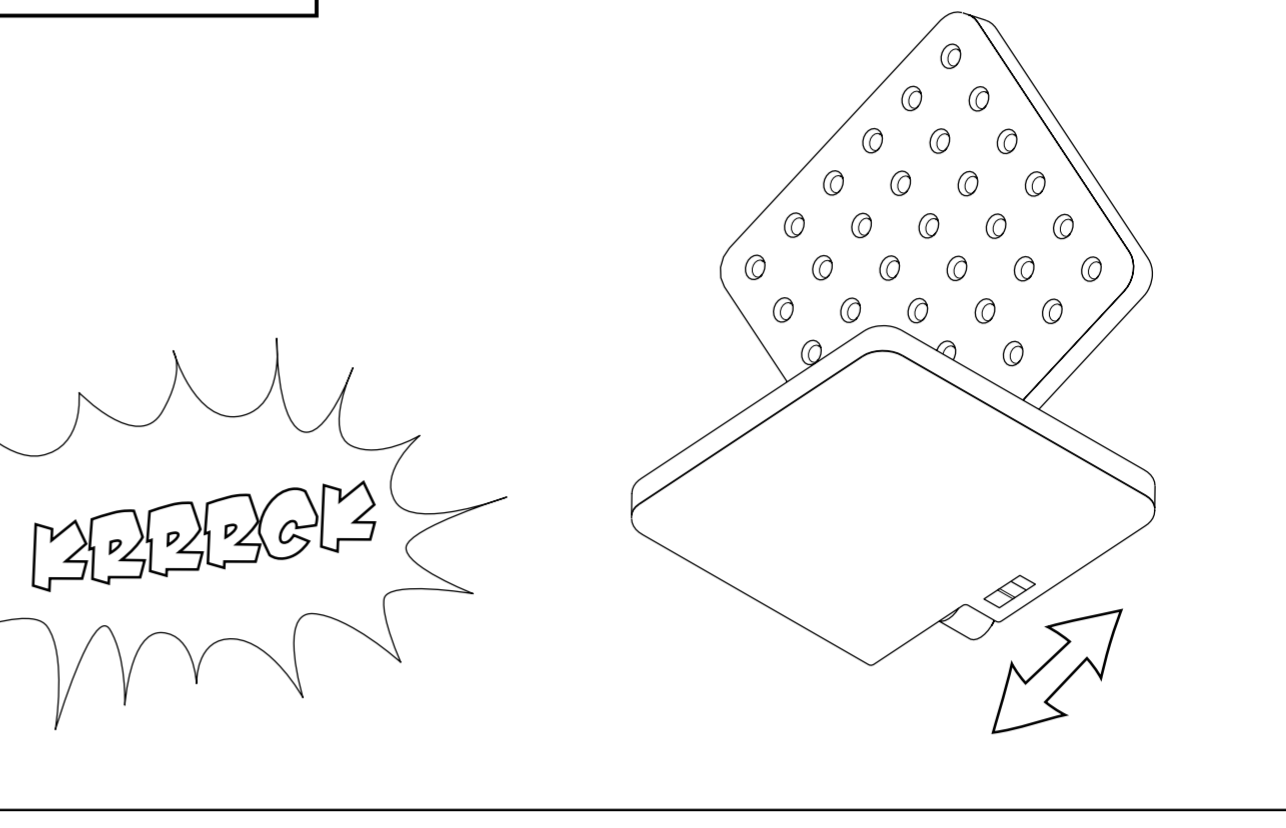

## LADEN CHARGE

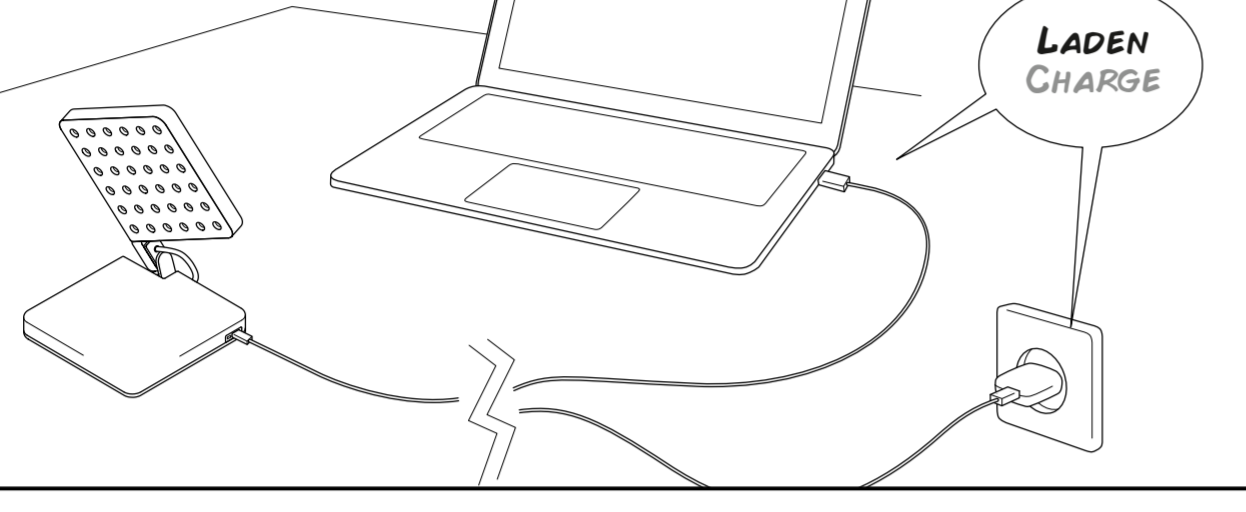

NACHDEM DER AKKU DURCH DEN GEBRAUCH DER LEUCHE ENTLADEN WURDE, SOLLTE EIN KOMPLETTER LADEZYKLUS ERFOLGEN. AFTER THE CELL WAS DISCHARGED BY THE USE OF THE LUMINAIRE YOU SHOULD START A COMPLETE CHARGE CYCLE.

## LEUCHTDAUER OPERATING TIME

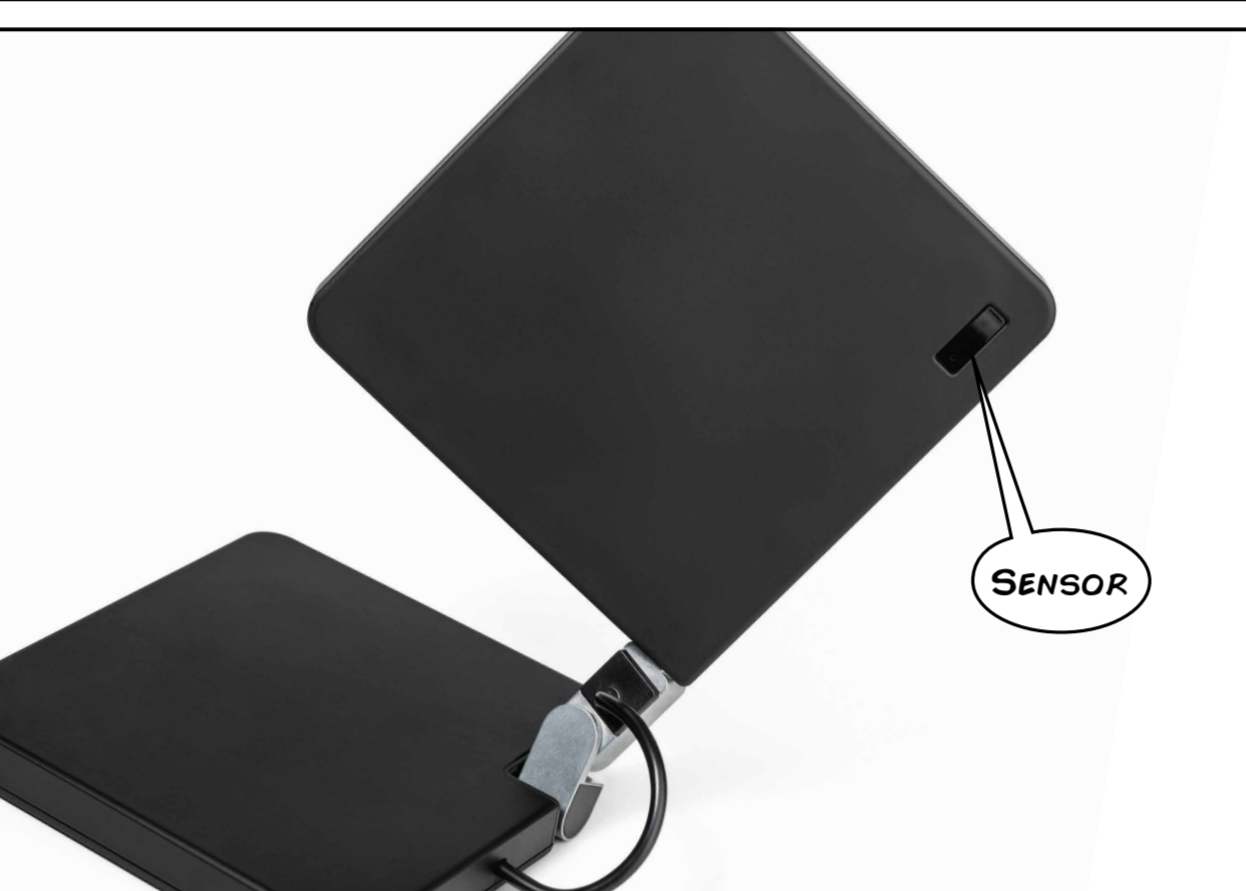
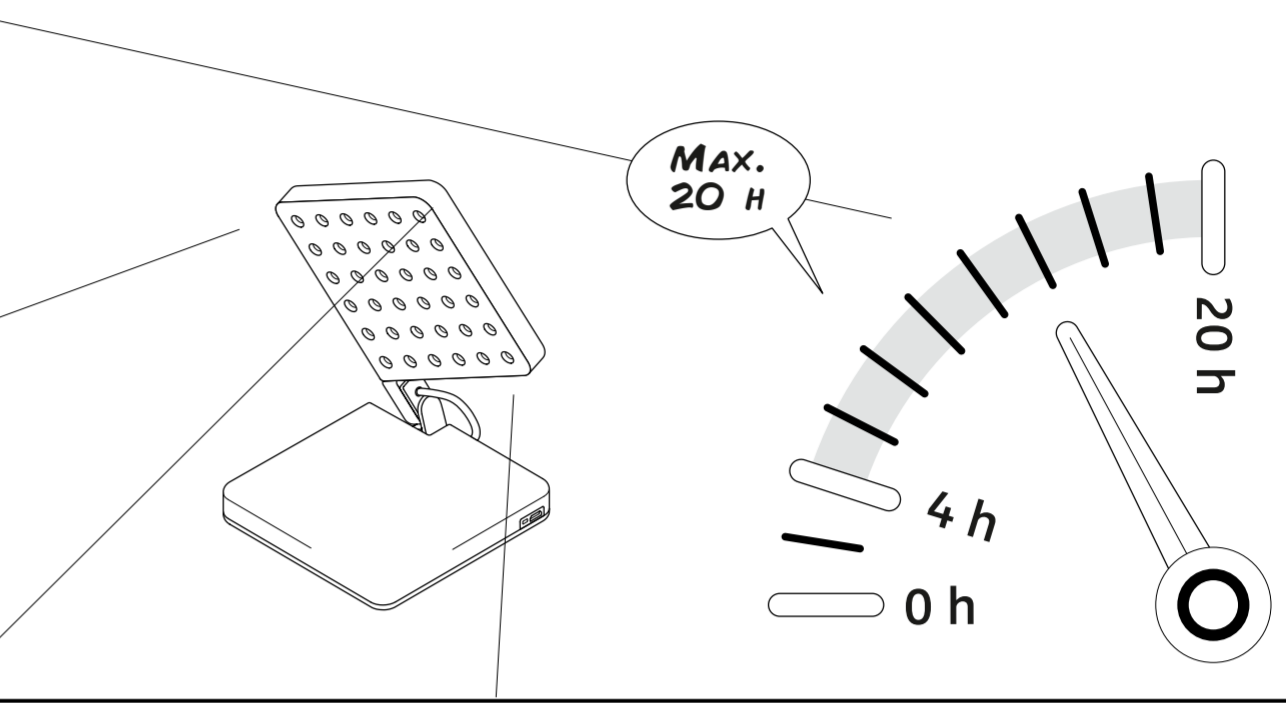

## BERÜHRUNGSLOSE GESTENSTEUERUNG GESTURE CONTROL

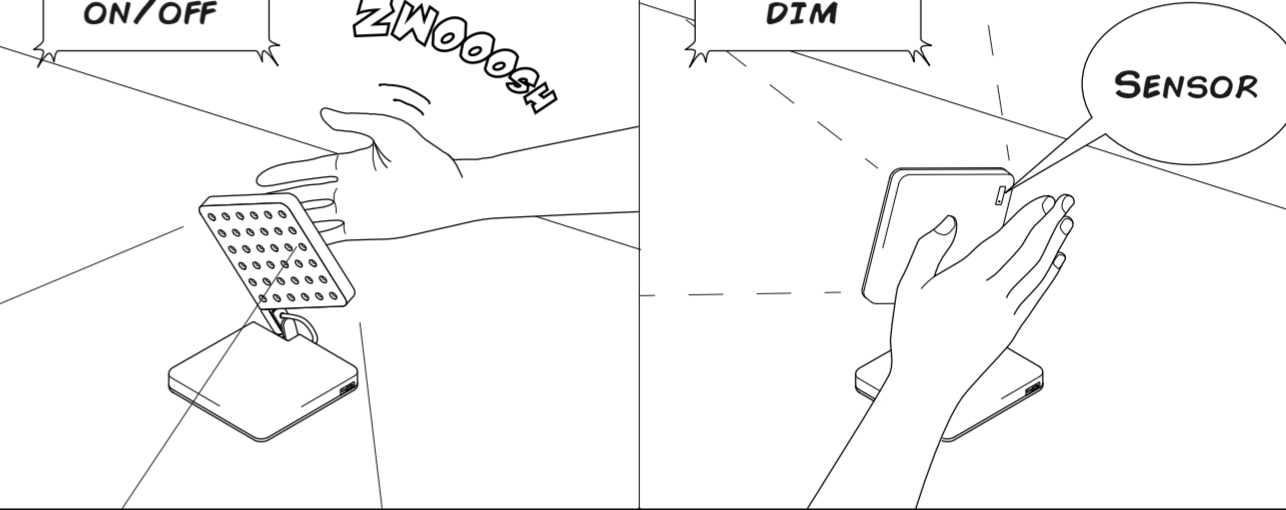

1-2 CM WAAGERECHT ÜBER DEN SENSOR WISCHEN. MAKE A HORIZONTAL SWIPING MOTION 1-2 CM ABOVE THE SENSOR.

DIE HAND 1-2 CM ÜBER DEM SENSOR SCHWEBEN LASSEN. LET YOUR HAND HOVER 1-2 CM ABOVE THE SENSOR.



## MAGNETE MAGNETS

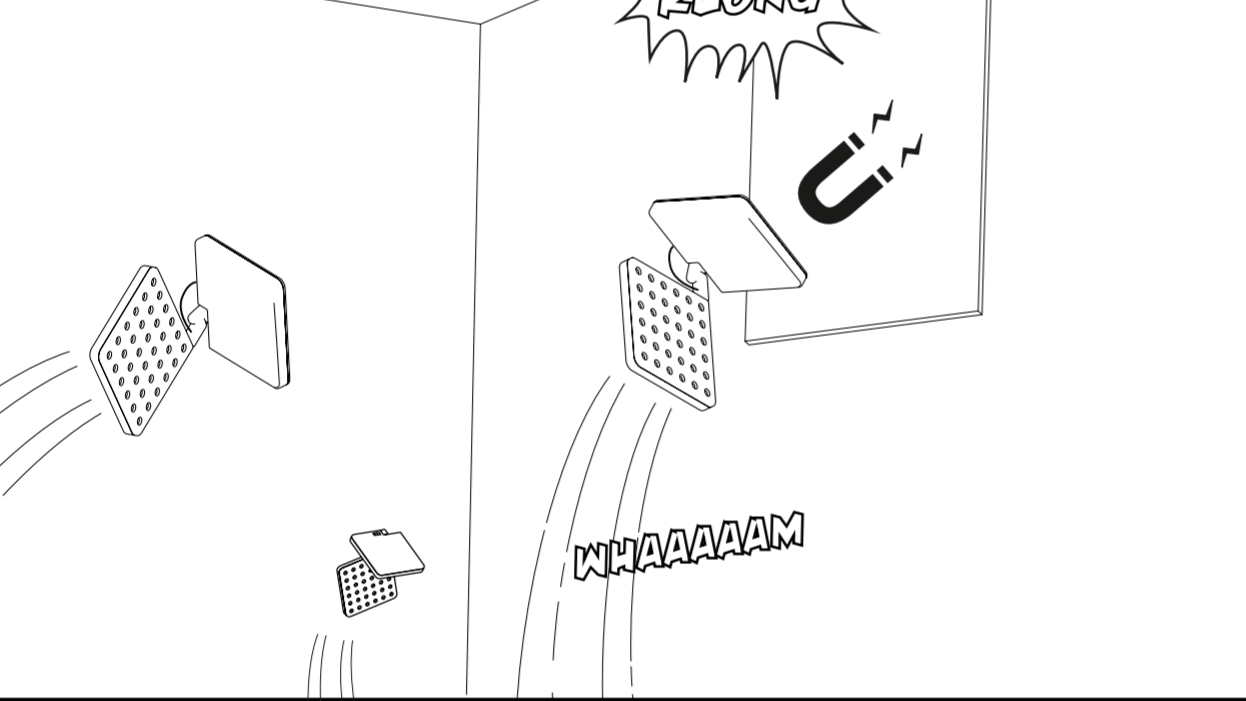

## BEWEGLICHER KOPF FLEXIBLE HEAD

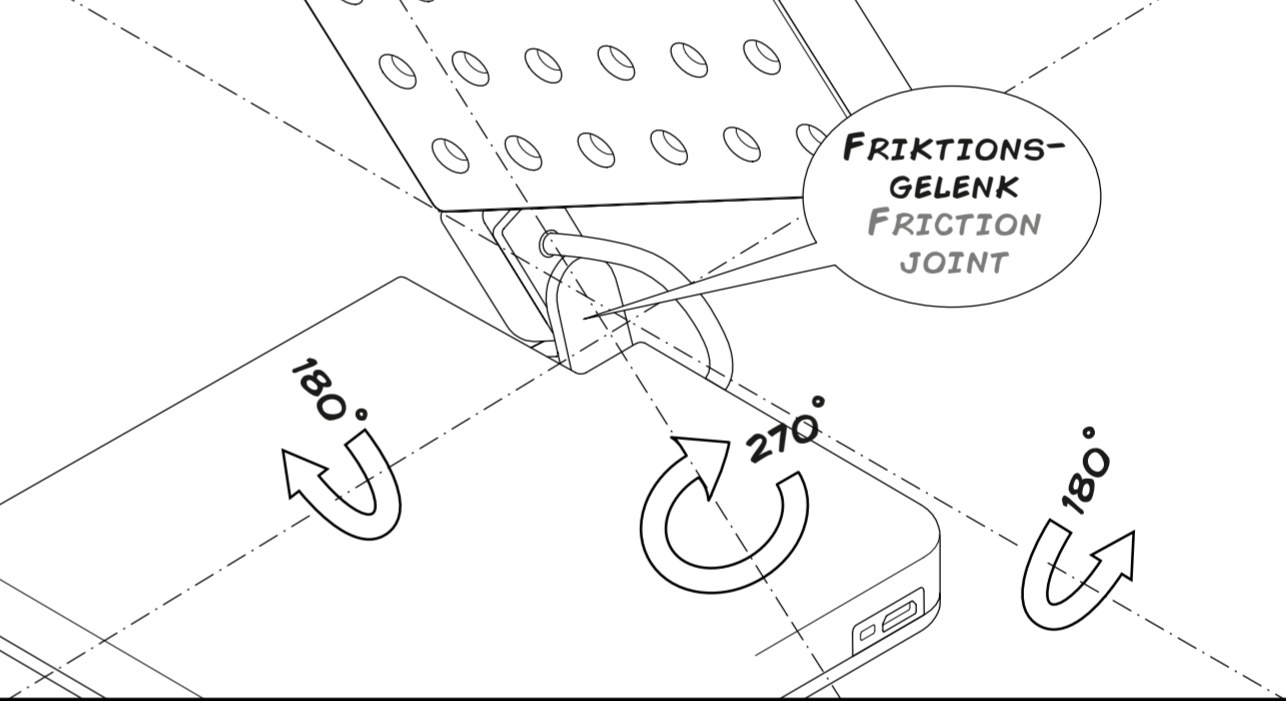

## STATUS-LED

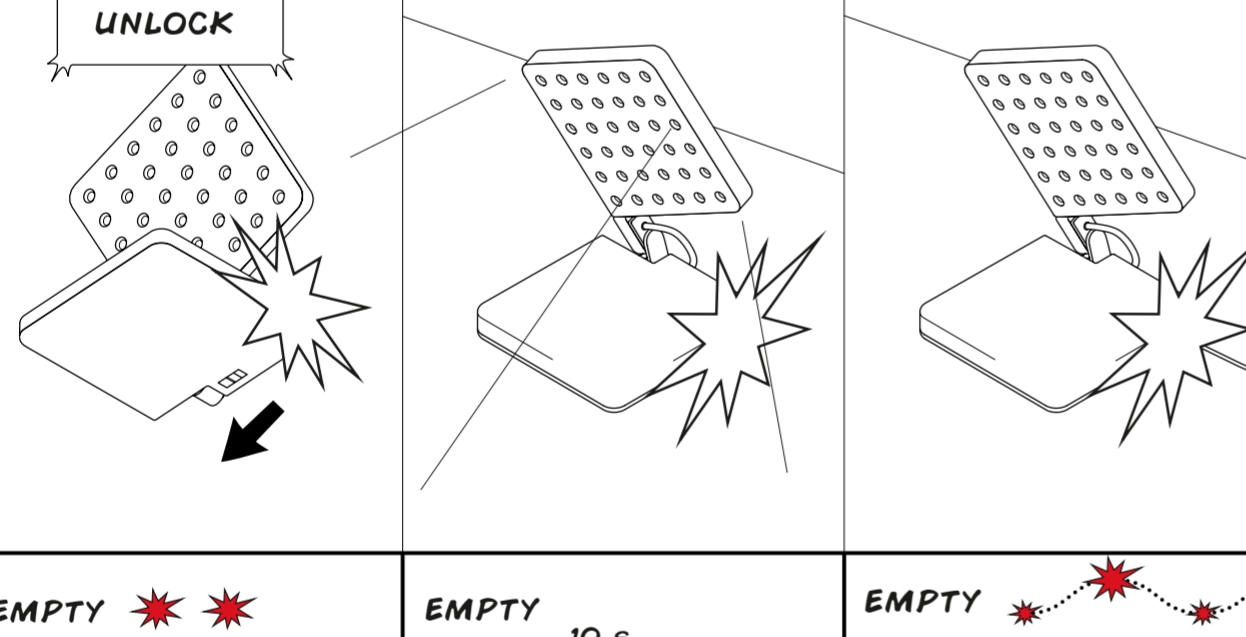

EMPTY FULL 10 s FULL



## ENERGIEEFFIZIENTE LEDS ENERGY-EFFICIENT LEDS

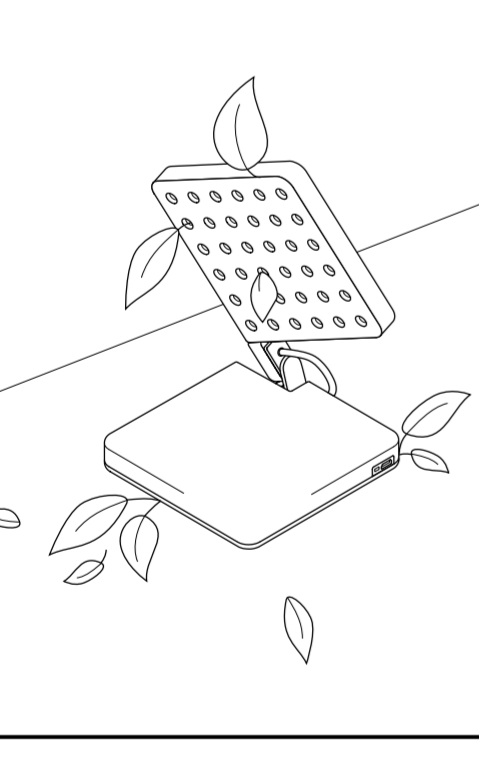

## LIGHT-TECHNOLOGY

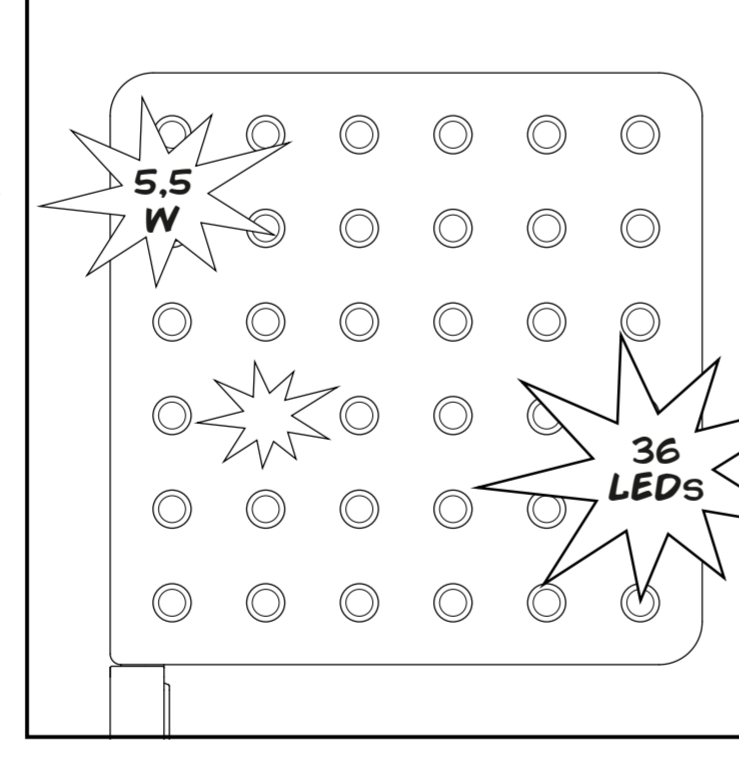

## UMGEBUNGSTEMPERATUR AMBIENT TEMPERATURE

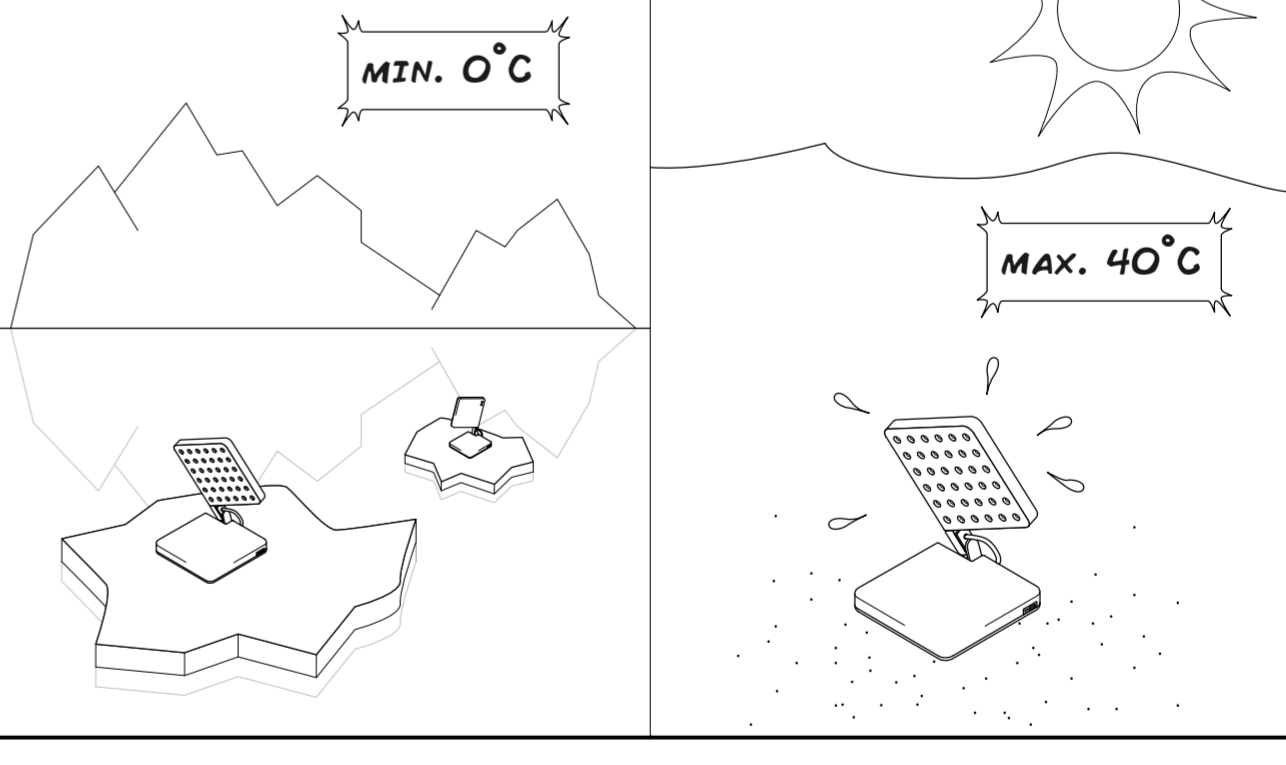

## GRÖSSE SIZE

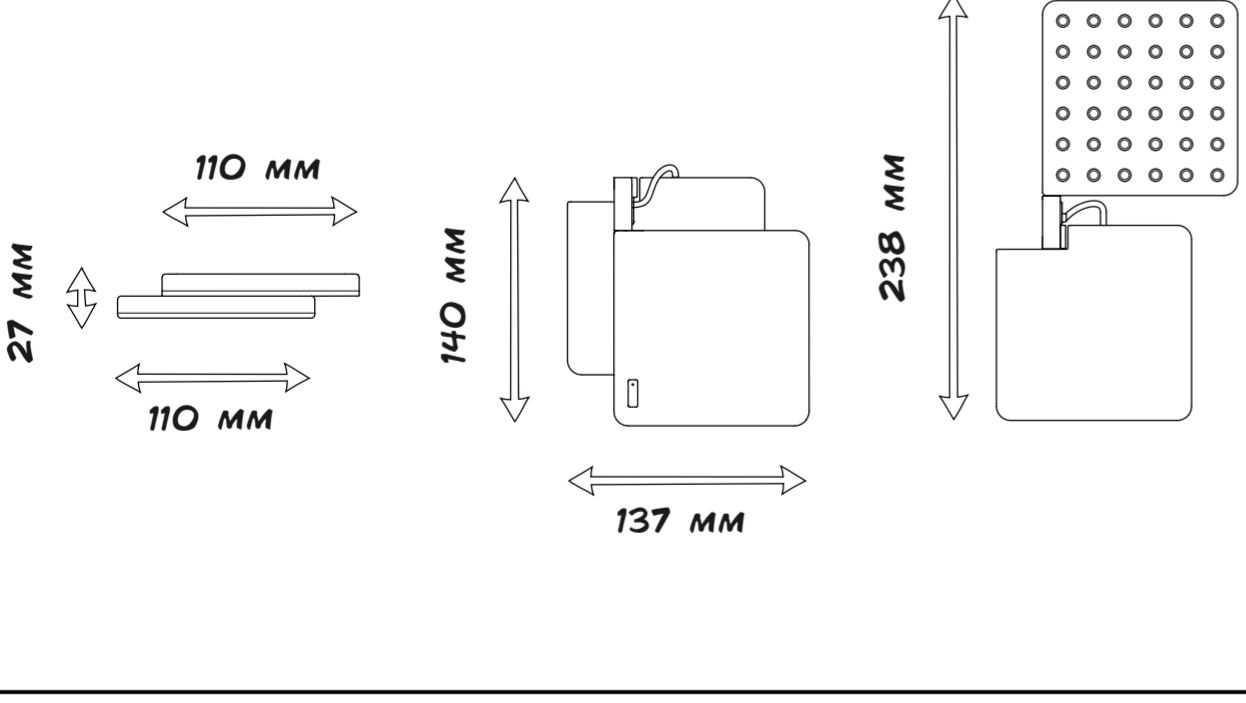

## GEWICHT WEIGHT

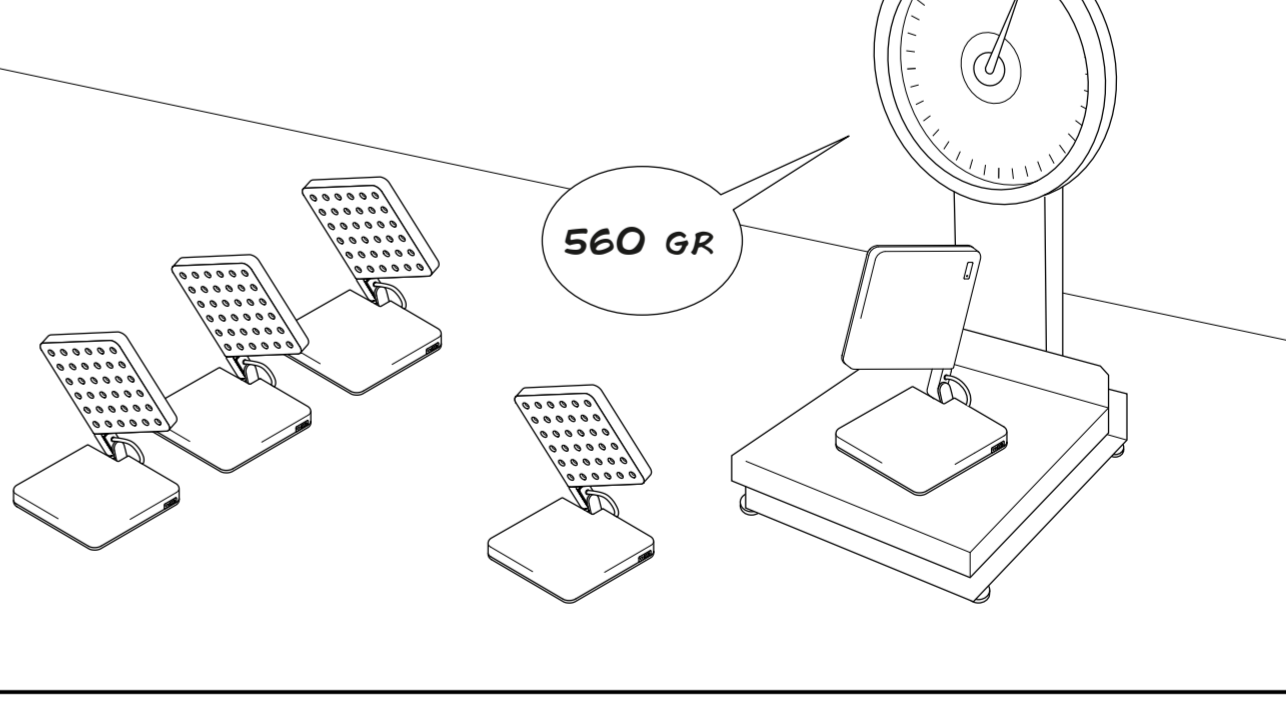

## AKKUWECHSEL REPLACEMENT OF BATTERY

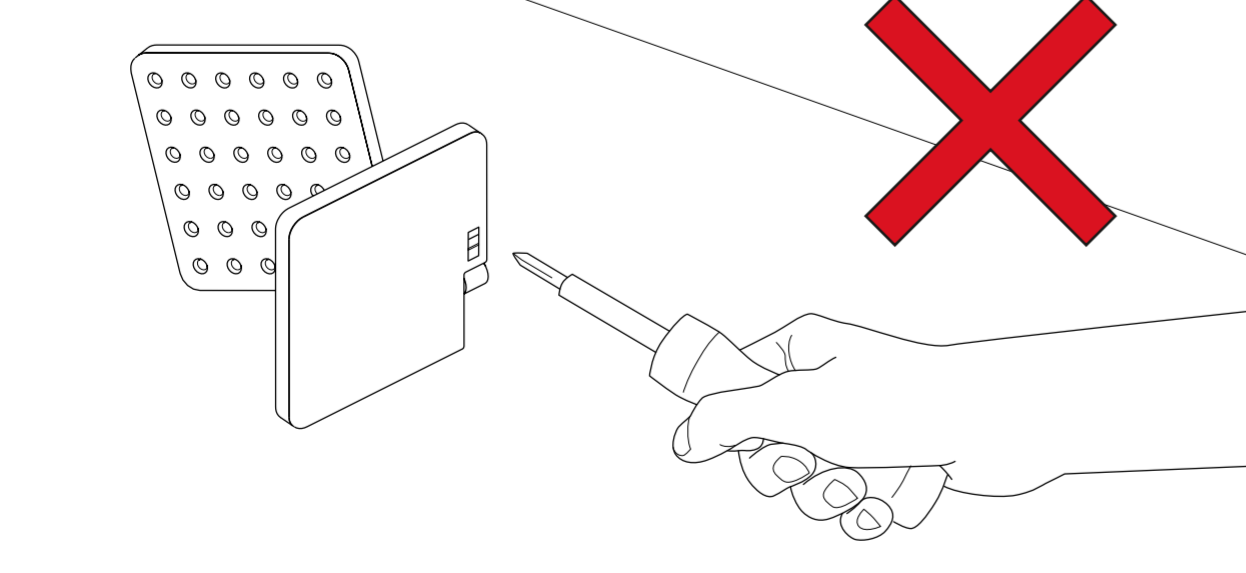

LEUCHE NICHT ÖFFNEN!!! BITTE AN DEN HERSTELLER WENDEN! DO NOT OPEN THE LUMINAIRE!!! PLEASE REFER TO THE MANUFACTURER!

## RECYCLING

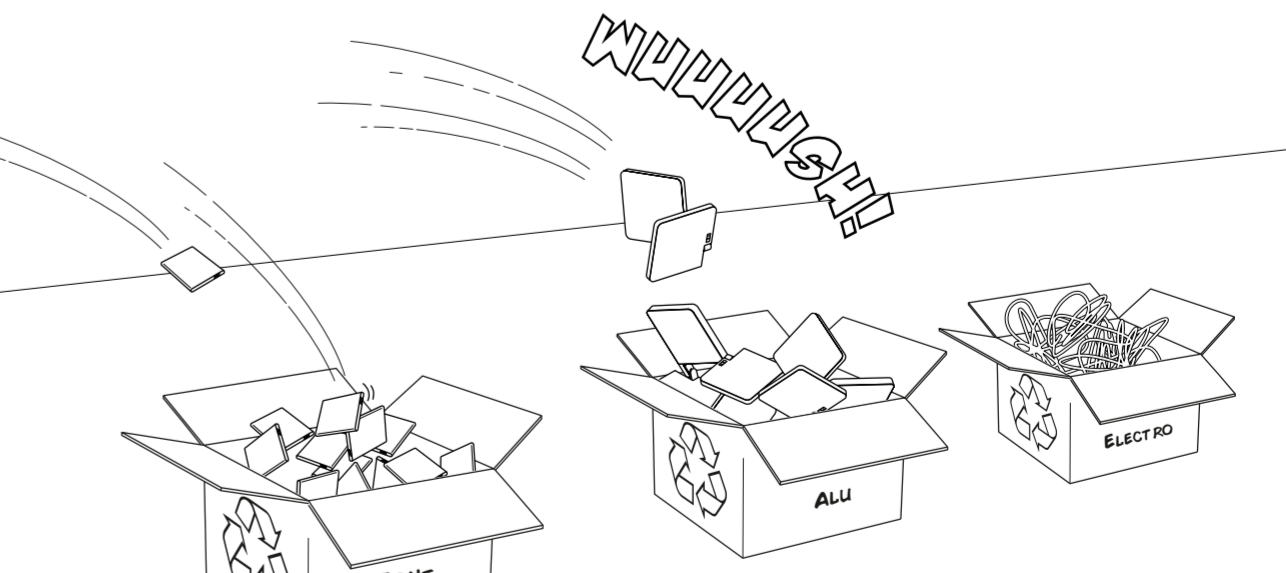

**BAAAM!**

